

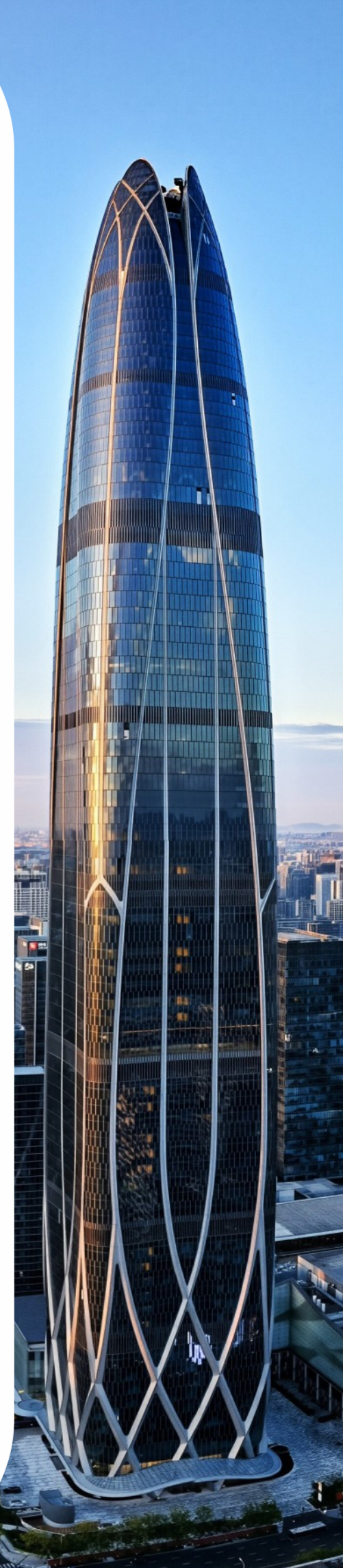

BY GNL GROUP



-  Home Elevator
-  Passenger Elevator
-  Observation Elevator
-  Hospital Elevator
-  Freight Elevator



NINGBO CONIC ELEVATOR CO., LTD.

地址：中国浙江省宁波市鄞州区潘火街道
Address: Panhuo Subdistrict, Yinzhou District, Ningbo City, Zhejiang Province, China

电话 (Phone) : +86-057455681351
邮箱 (Mail) : info@nbconic.com
网址 (Web) WWW.NBCONIC.COM



本印刷品仅作一般信息之用，本公司保留随时更改产品设计与规格的权利。
由于印刷工艺的限制，实际加工的颜色可能与本册略有不同之处，最终选型可根据实际材料和色样决定。

This print is for general information only. The company reserves the right to change the product design and specifications at any time.
Due to the limitations of the printing process, the actual processed colors may be slightly different from this volume. The final selection can be decided based on the actual materials and color samples.

宁波肯尼科电梯有限公司

NINGBO CONIC ELEVATOR CO., LTD.

我们能看到的只是电梯的一小部分。

WHAT WE CAN SEE IS ONLY A SMALL PART OF ELEVATOR

轿厢 操纵箱 外呼

CABIN COP LOP

许多其他关键组件仍被隐藏在我们视线之外
隐藏在我们视线之外的
这些不可见元素
可确保电梯安全高效运行

NUMEROUS OTHER ESSENTIAL COMPONENTS REMAIN
HIDDEN FROM OUR VIEW
AND THESE INVISIBLE ELEMENTS
CAN ENSURE THE ELEVATOR
OPERATES SAFELY AND EFFICIENTLY



NINGBO CONIC ELEVATOR CO., LTD.

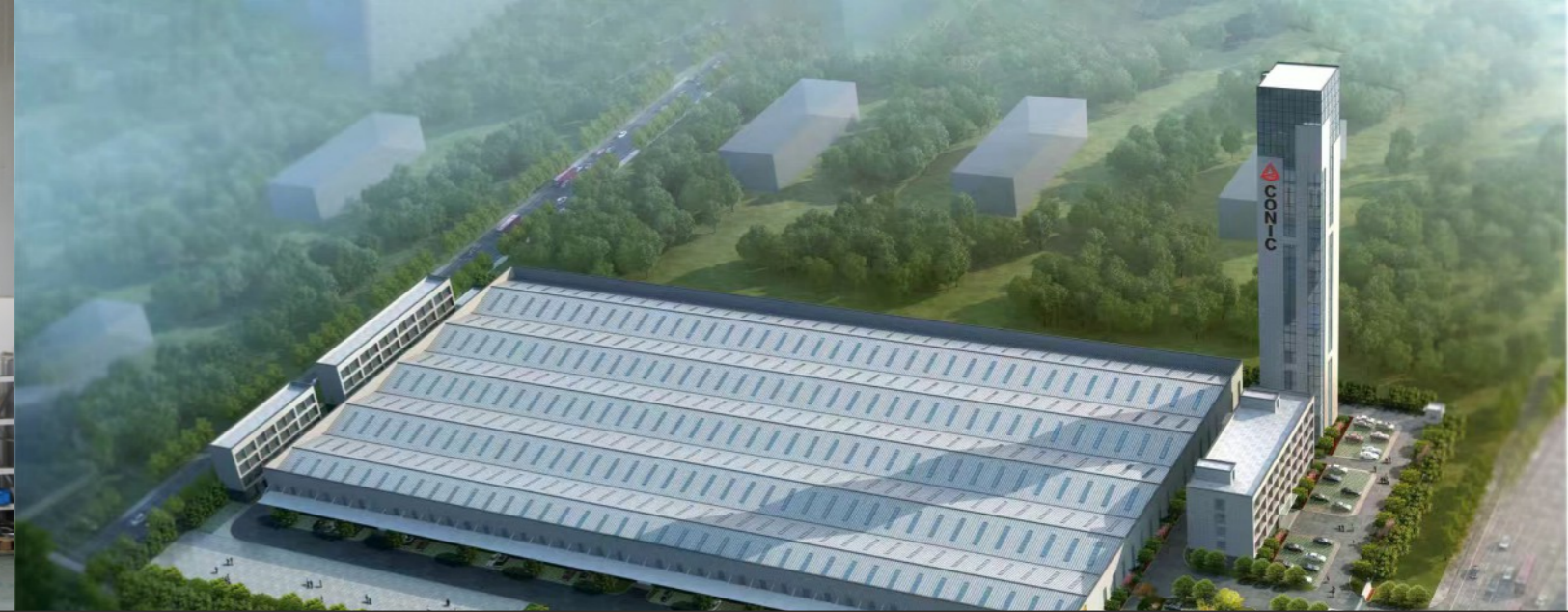

COMPANY PROFILE 公司简介

NINGBO CONIC ELEVATOR CO., LTD., located in Yinzhou District, Ningbo, Zhejiang Province, China, is a key member of **GNL GROUP** and a trusted manufacturer of elevators for residential, commercial, and industrial applications.

As a Sino-foreign invested company, we specialize in the design, manufacturing, and global distribution of high-quality elevator systems. With advanced technology, skilled engineering teams, and strict quality control, we deliver reliable, safe, and efficient vertical transportation solutions worldwide.

WHY CHOOSE US / 我们的优势

- International Certifications: CE & ISO
- One-Stop Complete Elevator Solution Provider
- Customized Design & Manufacturing & Global Export
- Premium Quality CONIC Branded Products
- Competitive & Best Market Prices
- Professional After-Sales Online Support by Experienced Engineers
- 24/7 Technical Support

Quality Assurance / 质量保证

- International standard certified, CE & ISO.
- High-quality GNL branded products
- Strict quality control from raw materials to finished goods

Customer Support / 客户服务

- 24/7 technical support
- Easy and fast ordering process
- Focus on safety, reliability, and customer satisfaction

About GNL GROUP | 关于歌诺团队

GNL Group is a trusted provider of comprehensive elevator solutions, supported by a network of specialized companies:

- 
Ningbo CONIC Elevator Co., Ltd.
 Manufacturer of complete elevators & supplier of premium elevators for domestic & global markets.
- 
Ningbo GNL Elevator Spare Parts Co., Ltd.
 Manufacturing and global supply of high-quality elevator spare parts.
- 
Ningbo Fuji Drive Co., Ltd.
 Manufacturing of advanced traction machines for elevator systems.
- 
GNL International Co., Ltd.
 Global digital marketing consultancy international business growth.

Together, we deliver complete, end-to-end elevator solutions—from individual components to fully integrated systems—serving customers worldwide with a strong commitment to quality, reliability, and innovation.

Connecting You to The New Heights / 带你攀登新的高峰....

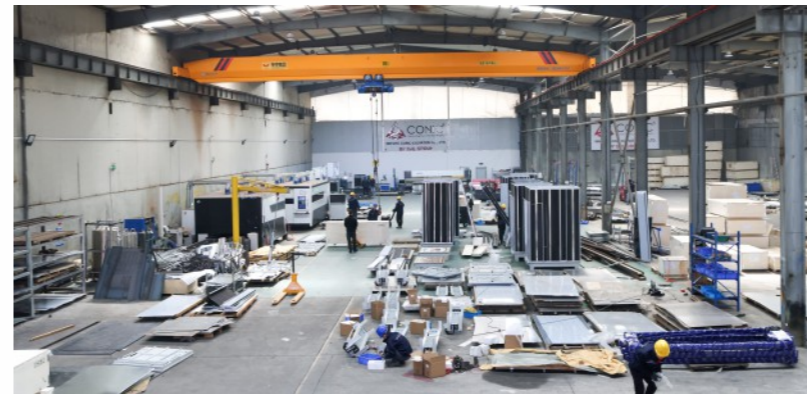

OUR PRODUCTS / 产品范围

- Home Elevator
- Hospital Elevator
- Freight Elevator
- Car Elevator
- Observation Elevator
- Passenger Elevator
- Dumbwaiter Elevator
- Stair Elevator

HONORS / 荣誉



NexusHome[®] Series

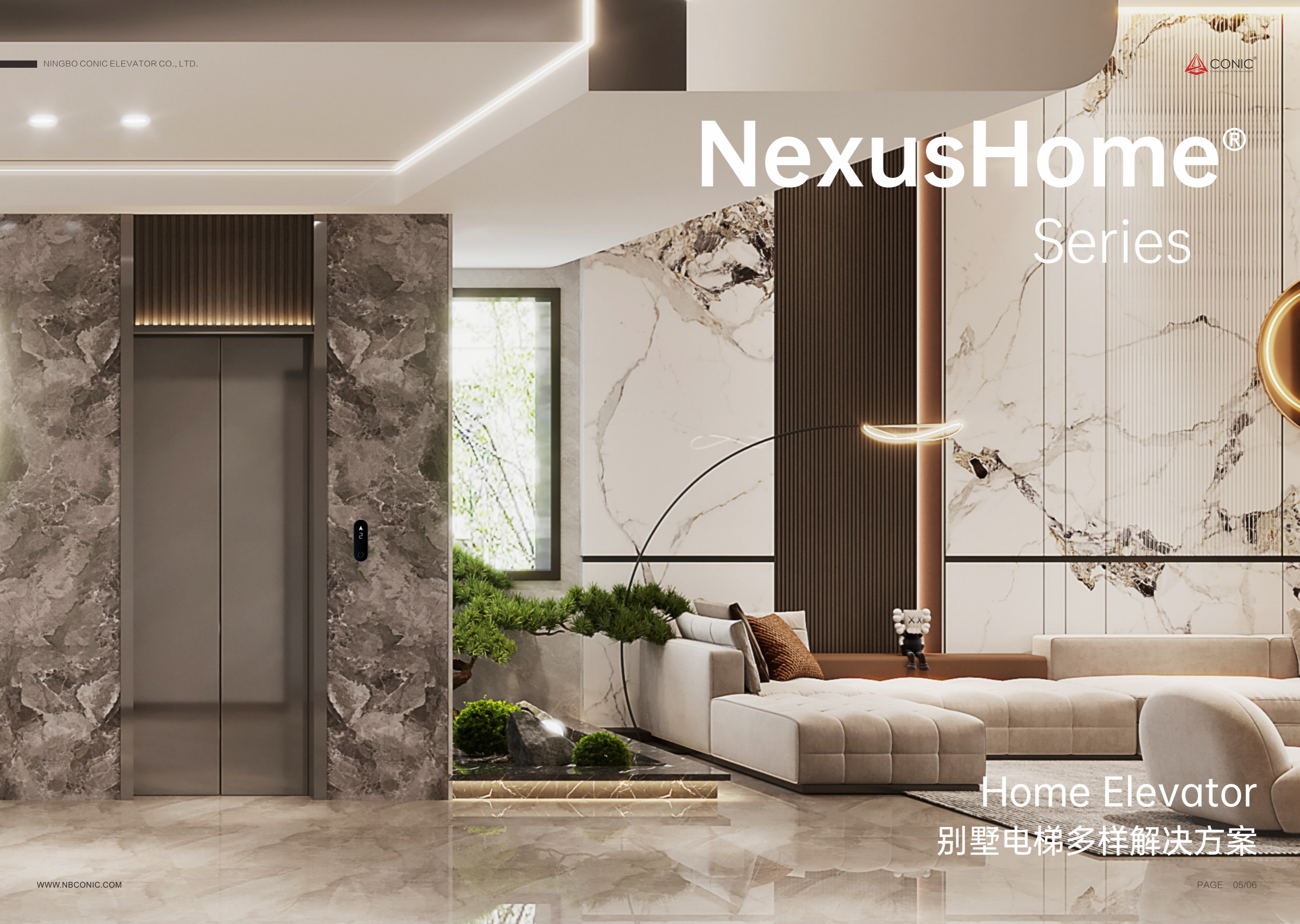

Home Elevator
別墅电梯多样解决方案

NexusHome[®] Series

Personalized Customization Door opening types & COP & LOP

别墅电梯个性化定制

它凸显美丽的工艺线条，配合先进的材料选择，诠释高端工业设计理念，使其成为您私人空间中美丽的艺术品之一。

It highlights the beautiful lines of craftsmanship, cooperates with advanced material selection, interprets the concept of high-end industrial design, and makes it one of the beautiful works of art in your private space.

安全方便，护理常伴随

Safe and convenient, care is often accompanied

是专门针对中高端别墅和错层住宅开发开发的，布局精致、风格多样、性能突出。适合别墅和无电梯的错层住宅，满足您的高品质生活需求。

It is specially developed for mid-to-high-end villas and split-level residences, with exquisite layout, diverse styles, and outstanding performance. It is suitable for villas and split-level residences without elevators to meet your high-quality life needs.

人性化开门方式

Humanized open door style

它采用多种开门方式为用户提供选择，并可根据需要和使用条件进行专门设计。

It adopts a variety of door opening methods to provide users with choices, and can be specially designed according to needs and usage conditions.



Elevator COP & LOP

电梯人机界面

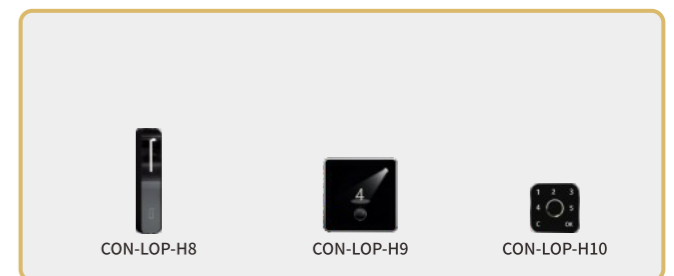
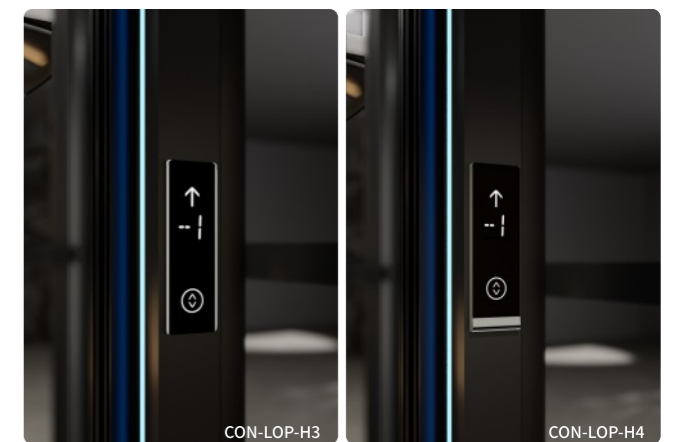
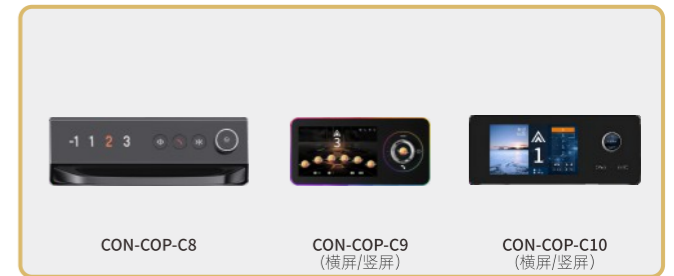
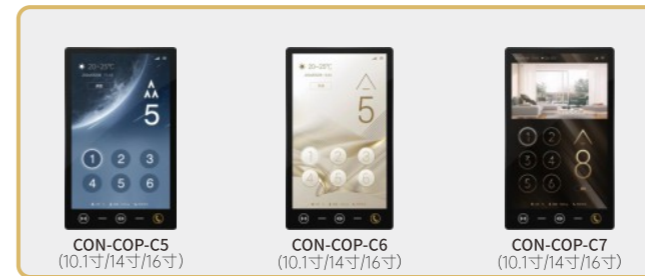

NexusHome[®] Series

Driver Solution For Home Elevator

别墅电梯多样解决方案

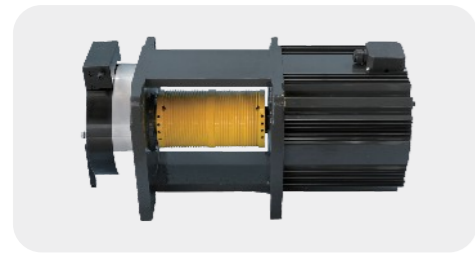

NexusHome Grip[®]
Strong Drive Traction Motor
强驱式别墅电梯

该类型电梯采用先进的电梯强制式驱动和数字化控制变频调速技术，运行平稳。无需对重，无齿轮箱，体积小，安装简便，完全可以实现无机房，相比较传统液压梯，节省成本，更节约空间。

This type of elevator adopts advanced elevator forced drive and digital control frequency conversion speed regulation technology, and it runs smoothly. There is no need for counterweight, no gearbox, small size, easy installation, and it can completely realize the machine roomless. Compared with the traditional hydraulic ladder, it saves cost and space.

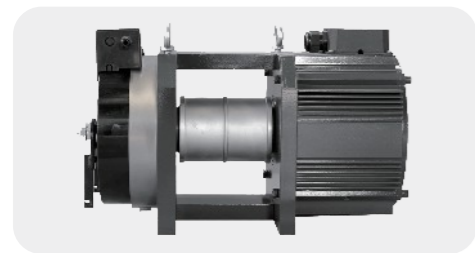

NexusHome Sync[®]
Belt Drive Motor
钢带式别墅电梯

新型的钢带曳引式别墅电梯产品，轿壁装饰为三面镶嵌式，中间装饰可拆卸，可采用不同材质，互换性更强，可满足客户的多样化、个性化需求。

A new type of steel belt traction villa elevator product, the car wall decoration is inlaid on three sides, the middle decoration is detachable, different materials can be used, and the interchangeability is stronger, which can meet the diversified and personalized needs of customers.

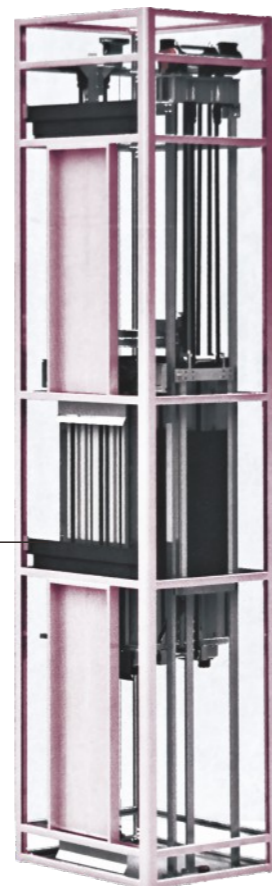
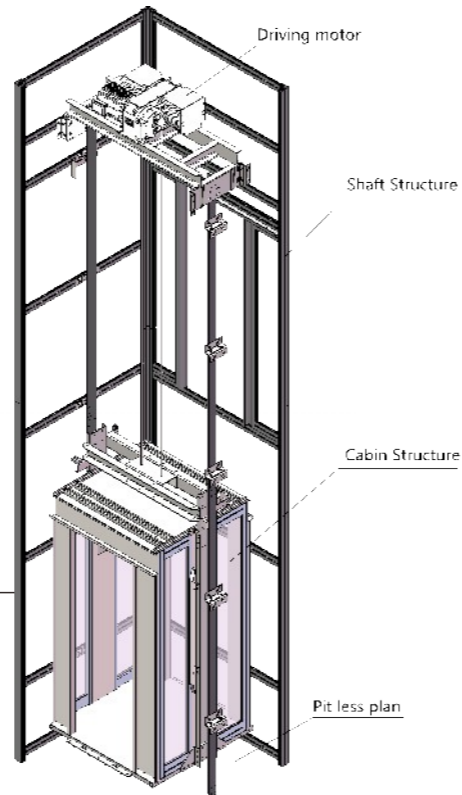

NexusHome Prime[®]
Steel Rope Traction Motor
钢丝绳曳引式别墅电梯

该类型电梯的驱动主机位于井道顶部侧置，两根主轨道位于轿厢左右两侧。因两侧受力均衡，电梯运行更平稳，乘坐适感更完美。采用钢丝绳曳引方式。

The main driving machine of this type of elevator is located on the top of the hoistway and the two main rails are located on the left and right sides of the car. Because the forces on both sides are balanced, the elevator runs more smoothly and the ride feels more complete. Steel wire rope traction method is adopted.



NexusHome Aqua[®]
Hydraulic Drive
液压型别墅电梯

液压式别墅电梯采用高性能、高质量的意大利进口高性能液压系统及先进的控制技术，其高精度比例阀能实现无极调速，而且具有稳定及良好的运行状态，可靠性高，运行成本低。

The hydraulic villa elevator adopts high-performance, high-quality Italian imported high-performance hydraulic system and advanced control technology. Its high-precision proportional valve can realize stepless speed regulation, and has stable and good operating conditions, high reliability, and low operating cost.





Sightseeing Villa Elevator Decoration series 观光别墅电梯装潢系列

可做到三侧开门; 想怎么进就怎么进
适合现有井道内安装
曳引驱动、高端定制、安全静音、五年质保

NexusHome® Series CORE-T200 Hoistway & Elevator 别墅电梯多样解决方案



CON-NXH-1 选配/Optional

吊顶: 闪银灰型材框架、LED灯带、亚克力透光板
轿壁: 闪银灰型材边框、5+5透明胶片夹胶(干胶)、闪银灰型材
一体式操纵箱隐藏式灯带、踢脚线暗藏灯带
轿门: 闪银灰型材、透明玻璃
地板: 岩板

Ceiling: Flash silver gray profile frame, LED light strip, acrylic transparent board
Car wall: flash silver grey profile frame, 5+5 transparent film laminated glue (dry glue), flash silver grey profile integrated control box hidden light band, skirting hidden light band
Car door: flash silver gray profile, transparent glass
Floor: Rock slab

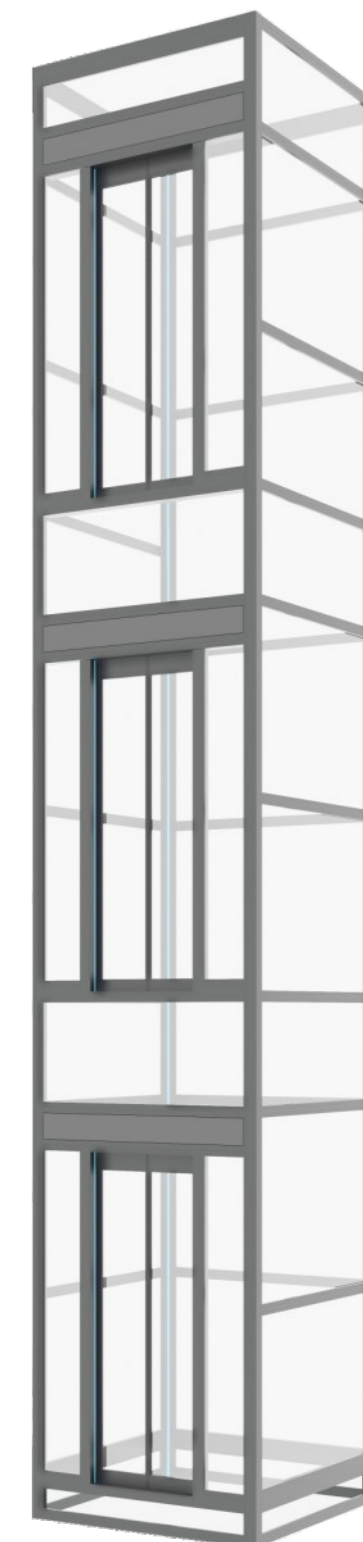

NexusHome[®] Series
CORE-T300 Hoistway & Elevator
 别墅电梯多样解决方案

NexusHome[®] Series
CORE-T400 Hoistway & Elevator
 别墅电梯多样解决方案



CON-NXH-2 选配/Optional
 闪银灰
 Sparkling silver gray



CON-NXH-3 选配/Optional
 香槟金
 Champagne gold



CON-NXH-4 选配/Optional
 闪银灰
 Sparkling silver gray



CON-NXH-5 选配/Optional
 香槟金
 Champagne gold



NexusHome® Series

CORE-T500 Hoistway & Elevator

别墅电梯多样解决方案



CON-NXH-6 选配/Optional
石墨黑
Graphite black



CON-NXH-7 选配/Optional
香槟金
Champagne gold



Sightseeing Villa Elevator
Decoration series
观光别墅电梯装潢系列

360度极目全景视野超高性价比
满足你所有需求, 你的需求你做主

NexusHome[®] Series

Home Elevator Decoration Series

別墅电梯装饰系列

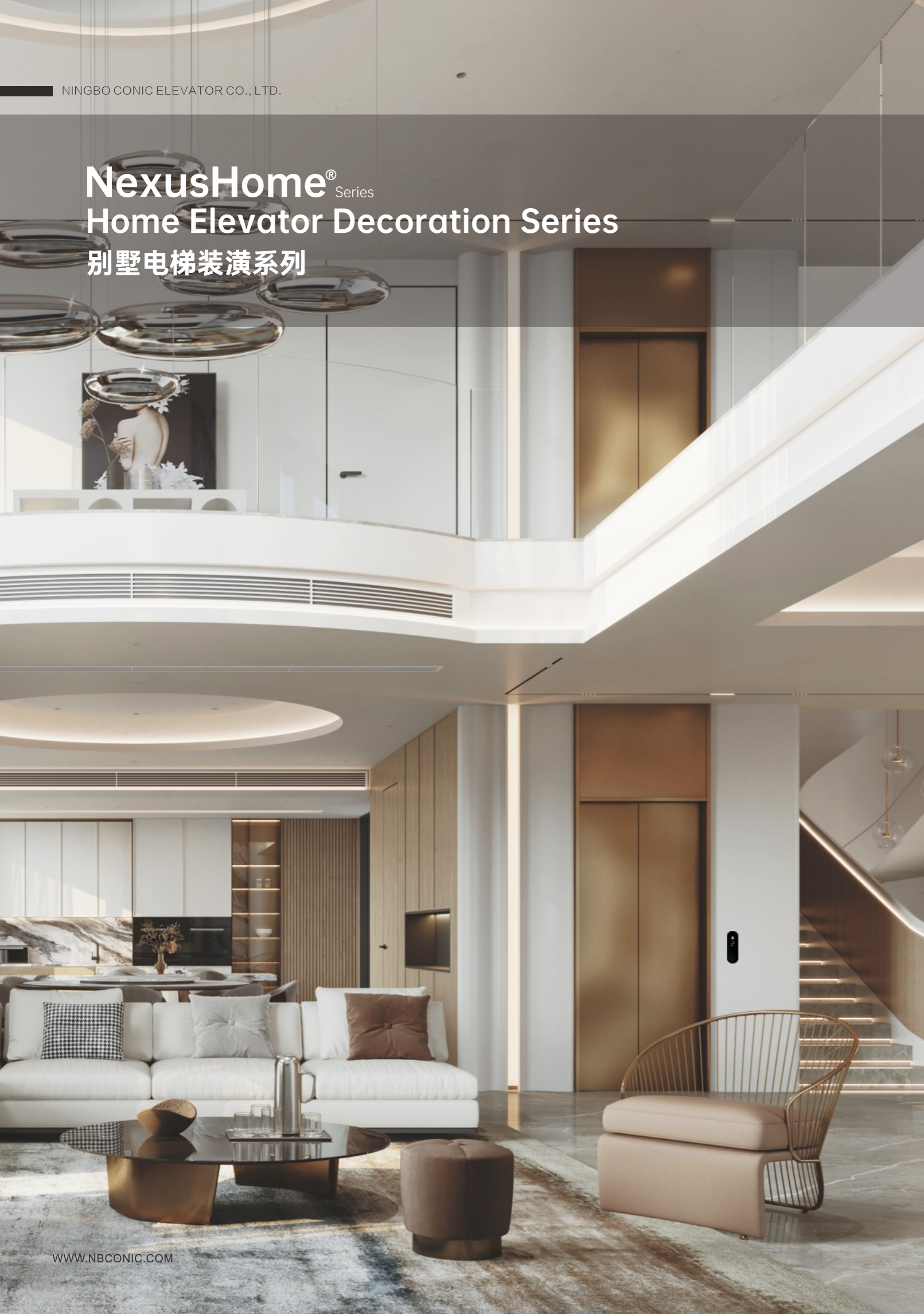

CON-NXH-8 标配/Standard

吊顶: 镜面不锈钢、亚克力透光板
轿壁: 304发纹不锈钢、中间玫瑰金镜面不锈钢
地板: 岩板

Ceiling: Mirror surface stainless steel, acrylic transparent board
Car wall: 304 Hairline stainless steel, rose gold mirror stainless steel in the middle
Floor: Rock slab

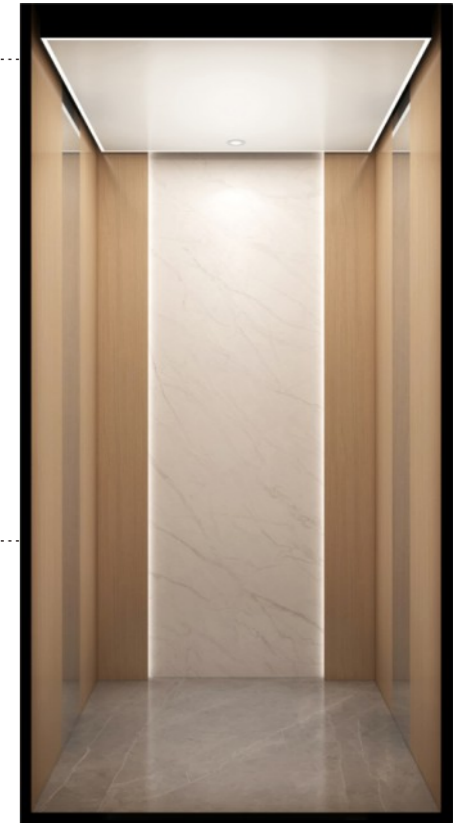

CON-NXH-9 标配/Standard

吊顶: 金属工艺板、LED灯带
轿壁: 金属工艺板、LED灯带、镜面不锈钢、岩板
地板: 岩板

Ceiling: Metal craft board, LED light strip
Car wall: Metal craft plate, LED light strip, mirror stainless steel, rock plate
Floor: Rock slab



CON-NXH-10 选配/Optional

吊顶: 石墨黑型材框架、LED灯带、亚克力透光板
轿壁: 石墨黑型材边框、铂多丽晶贴膜、踢脚线暗藏灯带
地板: 岩板

Ceiling: Graphite black profile frame, LED light strip, acrylic transparent board
Car wall: Graphite black profile frame, platinum regent film, skirting line hidden light band
Floor: Rock slab



CON-NXH-11 选配/Optional

吊顶: 发纹不锈钢、LED灯带、LED筒灯
轿壁: 古铜镜面不锈钢、大理石饰面、木饰面、暗藏灯带、钛金饰条
扶手: 钛金发纹圆扶手
地板: 岩板

Ceiling: Hairline stainless steel, LED strip, LED downlight
Car wall: Bronze mirror stainless steel, marble finish, wood finish, hidden light band, titanium trim strip
Handrails: Titanium blond round handrails
Floor: Rock slab



CON-NXH-12

选配/Optional

吊顶: 古铜色钢板、LED灯带
轿壁: 古铜色钢板、蚀刻花纹
地板: PVC (可选大理石)

Ceiling: Bronze-colored steel plate, LED light strip
Car wall: Bronze-colored steel plate with etched pattern
Floor: PVC (marble optional)

扫描二维码 观看轿厢
Scan the QR code watch the car



CON-NXH-13

选配/Optional

吊顶: 烤漆、黑钛发纹饰条、暗藏灯带、筒灯
轿壁: 艺术玻璃、黑钛发纹、暗藏灯带、木纹钢板
地板: PVC (可选大理石)

Ceiling: Baked enamel finish, black titanium hairline trim, recessed LED light strip, downlights
Car wall: Art glass, black titanium hairline finish, recessed LED light strip, wood grain steel plate
Floor: PVC (marble optional)

扫描二维码 观看轿厢
Scan the QR code watch the car



CON-NXH-17

选配/Optional

吊顶: 星空顶
轿壁: 黑钛发纹不锈钢、烤漆、皮革、木饰面、暗藏灯带
地板: PVC (可选大理石)

Ceiling: Starry sky ceiling
Car wall: Black titanium hairline stainless steel, baked enamel finish, leather, wood veneer, recessed LED light strip
Floor: PVC (marble optional)

扫描二维码 观看轿厢
Scan the QR code watch the car

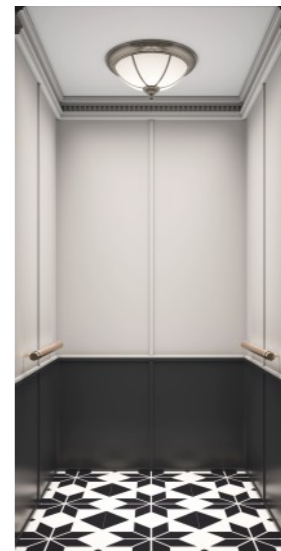

CON-NXH-18

选配/Optional

吊顶: 乳白色钢板、造型灯
轿壁: 乳白色钢板、黑钛钢板
地板: PVC (可选大理石)

Ceiling: Cream white steel plate with decorative, styled lighting
Car wall: Cream white steel plate, black titanium steel plate
Floor: PVC (marble optional)

扫描二维码 观看轿厢
Scan the QR code watch the car



CON-NXH-14

选配/Optional

吊顶: 木纹钢板、喷涂钢板、黑钛不锈钢、暗藏灯带、LED灯
轿壁: 木纹钢板、喷涂钢板、暗藏灯带
地板: PVC (可选大理石)

Ceiling: Wood grain steel plate, painted steel plate, black titanium stainless steel, recessed LED light strip, LED lights
Car wall: Wood grain steel plate, painted steel plate, recessed LED light strip
Floor: PVC (marble optional)

扫描二维码 观看轿厢
Scan the QR code watch the car



CON-NXH-15

选配/Optional

吊顶: 烤漆、筒灯灯、线形灯
轿壁: 科技柚木、镜面不锈钢、线形灯
地板: PVC (可选大理石)

Ceiling: Baked enamel finish, downlights, linear lights
Car wall: Technical teak, mirror-finished stainless steel, linear lights
Floor: PVC (marble optional)

扫描二维码 观看轿厢
Scan the QR code watch the car

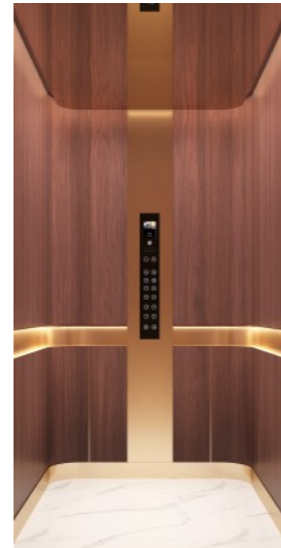

CON-NXH-19

选配/Optional

吊顶: 镜面不锈钢
轿壁: 木纹钢板、玫瑰金发纹不锈钢
地板: PVC (可选大理石)

Ceiling: Mirror-finished stainless steel
Car wall: Wood grain steel plate, rose gold hairline stainless steel
Floor: PVC (marble optional)

扫描二维码 观看轿厢
Scan the QR code watch the car



CON-NXH-21

选配/Optional

吊顶: 底板、高光免漆皮革压纹、射灯
轿壁: 皮革压纹、白橡半透烤漆、发纹不锈钢
地板: PVC (可选大理石)

Ceiling: Base panel, high-gloss no-paint leather embossed finish, spotlights
Car wall: Leather embossed finish, white oak translucent baked enamel, hairline stainless steel
Floor: PVC (marble optional)

扫描二维码 观看轿厢
Scan the QR code watch the car



CON-NXH-16

选配/Optional

吊顶: 铝合金边框、透光板
轿壁: 鱼肚白铝蜂窝、黑色边框、灯光、纯黑合金艺术钢板
地板: PVC (可选大理石)

Ceiling: Aluminum alloy frame with translucent panel
Car wall: Fish-belly white aluminum honeycomb panel, black frame, integrated lighting, pure black alloy art steel plate
Floor: PVC (marble optional)

扫描二维码 观看轿厢
Scan the QR code watch the car



CON-NXH-20

选配/Optional

吊顶: 冰川白饰面板、LED灯带
轿壁: 黑胡桃饰面、水性超纤皮革、格栅饰面金属包边
地板: PVC (可选大理石)

Ceiling: Glacier white decorative panel, LED light strip
Car wall: Black walnut veneer, water-based microfiber leather, grille decorative finish with metal edging
Floor: PVC (marble optional)

扫描二维码 观看轿厢
Scan the QR code watch the car





CON-NXH-22

选配/Optional

吊顶: 正白艺术钢板、LED灯
轿壁: 黄白橡艺术钢板、鱼肚白石纹艺术钢板
地板: PVC (可选大理石)

Ceiling: Pure white art steel plate with LED lights
Car wall: Yellow-white oak art steel plate, fish-belly white stone grain art steel plate
Floor: PVC (marble optional)



扫描二维码 观看轿厢
Scan the QR code watch the car



CON-NXH-23

选配/Optional

吊顶: 镜面不锈钢、筒灯、LED灯带
轿壁: 黑金沙艺术钢板、白金砂艺术钢板
地板: PVC (可选大理石)

Ceiling: Mirror-finished stainless steel, downlights, LED light strip
Car wall: Black gold sand art steel plate, white gold sand art steel plate
Floor: PVC (marble optional)



扫描二维码 观看轿厢
Scan the QR code watch the car

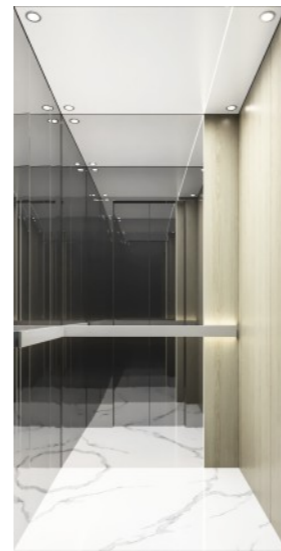

CON-NXH-27

选配/Optional

吊顶: 喷涂钢板、灯带、筒灯
轿壁: 木饰面覆膜不锈钢、镜面不锈钢、不锈钢扶手
地板: PVC (可选大理石)

Ceiling: Painted steel plate, LED light strip, downlights
Car wall: Wood grain laminated stainless steel, mirror-finished stainless steel, stainless steel handrail
Floor: PVC (marble optional)



扫描二维码 观看轿厢
Scan the QR code watch the car



CON-NXH-28

选配/Optional

吊顶: 古铜发纹不锈钢、暗藏灯带
轿壁: 木纹钢板、镜面不锈钢
地板: PVC (可选大理石)

Ceiling: Bronze hairline stainless steel, recessed LED light strip
Car wall: Wood grain steel plate, mirror-finished stainless steel
Floor: PVC (marble optional)



扫描二维码 观看轿厢
Scan the QR code watch the car



CON-NXH-24

选配/Optional

吊顶: 爱马仕橙一体式不锈钢吊顶、筒灯、线性灯
轿壁: 爱马仕橙不锈钢、雅白不锈钢、线性灯
地板: PVC (可选大理石)

Ceiling: Hermès orange integrated stainless steel ceiling, downlights, linear lights
Car wall: Hermès orange stainless steel, elegant white stainless steel, linear lights
Floor: PVC (marble optional)



扫描二维码 观看轿厢
Scan the QR code watch the car



CON-NXH-25

选配/Optional

吊顶: 喷涂钢板、隐藏式灯带、筒灯
轿壁: 雅白皮纹艺术钢板、木纹钢板
地板: PVC (可选大理石)

Ceiling: Painted steel plate, recessed LED light strip, downlights
Car wall: Elegant white leather-grain art steel plate, wood grain steel plate
Floor: PVC (marble optional)



扫描二维码 观看轿厢
Scan the QR code watch the car



CON-NXH-26

选配/Optional

吊顶: 镜面不锈钢、隐藏灯带、LED灯
轿壁: 白金砂幻彩金属饰面板、黑金沙幻彩金属饰面板
地板: PVC (可选大理石)

Ceiling: Mirror-finished stainless steel, recessed LED light strip, LED lights
Car wall: Fish-belly white aluminum honeycomb panel, black frame, integrated lighting, pure black alloy art steel plate
Floor: PVC (marble optional)



扫描二维码 观看轿厢
Scan the QR code watch the car



CON-NXH-29

选配/Optional

吊顶: 喷涂钢板、灯带、筒灯
轿壁: 科技木饰面、镜面不锈钢
地板: PVC (可选大理石)

Ceiling: Painted steel plate, LED light strip, downlights
Car wall: Technical wood veneer, mirror-finished stainless steel
Floor: PVC (marble optional)



扫描二维码 观看轿厢
Scan the QR code watch the car



CON-NXH-30

选配/Optional

吊顶: 镜面不锈钢、LED灯
轿壁: 黑色艺术合金板、艺术合金板
地板: PVC (可选大理石)

Ceiling: Mirror-finished stainless steel, LED lights
Car wall: Black art alloy panel, art alloy panel
Floor: PVC (marble optional)



扫描二维码 观看轿厢
Scan the QR code watch the car



CON-NXH-31

选配/Optional

吊顶: 发纹不锈钢、筒灯
轿壁: 木纹钢板、喷涂钢板
地板: PVC (可选大理石)

Ceiling: Hairline stainless steel, downlights
Car wall: Wood grain steel plate, painted steel plate
Floor: PVC (marble optional)



扫描二维码 观看轿厢
Scan the QR code watch the car



CON-NXH-32

选配/Optional

吊顶：喷涂钢板、LED灯
轿壁：黑钛发纹不锈钢、木纹钢板
地板：PVC（可选大理石）

Ceiling: Painted steel plate, LED lights
Car wall: Black titanium hairline stainless steel, wood grain steel plate
Floor: PVC (marble optional)



扫描二维码 观看轿厢
Scan the QR code watch the car

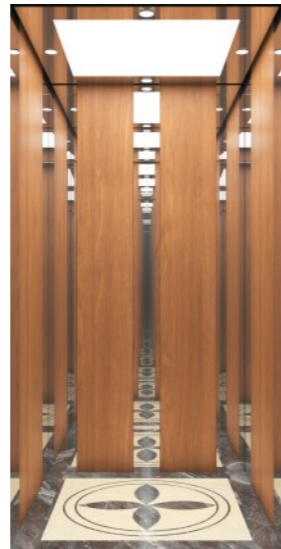

CON-NXH-33

选配/Optional

吊顶：镜面不锈钢、透光板、LED灯
轿壁：木纹钢板、镜面不锈钢
地板：PVC（可选大理石）

Ceiling: Mirror-finished stainless steel, translucent panel, LED lights
Car wall: Wood grain steel plate, mirror-finished stainless steel
Floor: PVC (marble optional)



扫描二维码 观看轿厢
Scan the QR code watch the car



CON-NXH-37

选配/Optional

吊顶：木纹钢板、LED灯
轿壁：蚀刻、木纹钢板、镜面不锈钢
地板：PVC（可选大理石）

Ceiling: Wood grain steel plate, LED lights
Car wall: Etched finish, wood grain steel plate, mirror-finished stainless steel
Floor: PVC (marble optional)



扫描二维码 观看轿厢
Scan the QR code watch the car



CON-NXH-38

选配/Optional

吊顶：喷涂钢板、LED灯
轿壁：木纹钢板、凹凸钢板、包边不锈钢、LED灯带
地板：PVC（可选大理石）

Ceiling: Painted steel plate, LED lights
Car wall: Wood grain steel plate, embossed steel plate, stainless steel edging, LED light strip
Floor: PVC (marble optional)



扫描二维码 观看轿厢
Scan the QR code watch the car

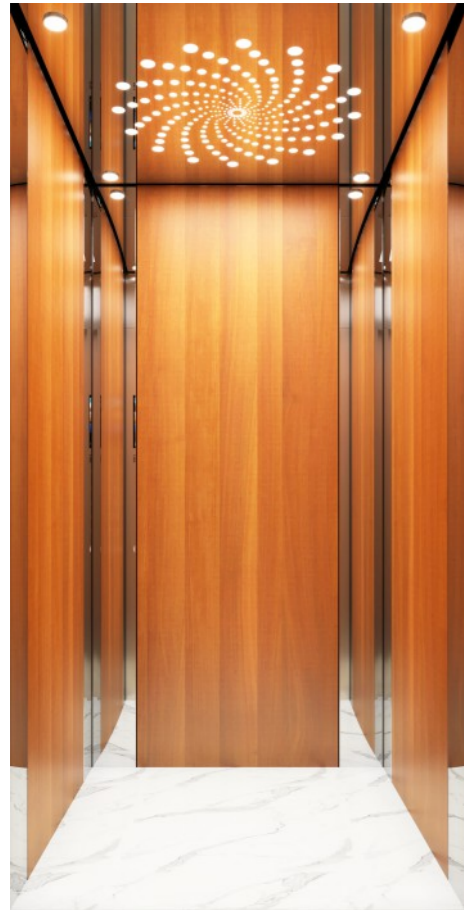

CON-NXH-35

选配/Optional

吊顶：镜面不锈钢、透光板、LED灯
轿壁：木纹钢板、镜面不锈钢
地板：PVC（可选大理石）

Ceiling: Mirror-finished stainless steel, translucent panel, LED lights
Car wall: Wood grain steel plate, mirror-finished stainless steel
Floor: PVC (marble optional)



扫描二维码 观看轿厢
Scan the QR code watch the car

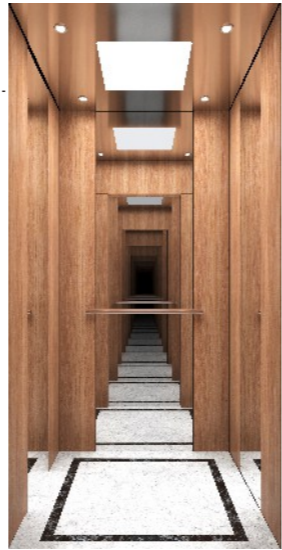

CON-NXH-36

选配/Optional

吊顶：镜面不锈钢、LED灯
轿壁：木纹钢板、镜面不锈钢
地板：PVC（可选大理石）

Ceiling: Mirror-finished stainless steel, LED lights
Car wall: Wood grain steel plate, mirror-finished stainless steel
Floor: PVC (marble optional)



扫描二维码 观看轿厢
Scan the QR code watch the car



CON-NXH-39

选配/Optional

吊顶：镜面不锈钢框架、亚克力透光板
轿壁：艺术玻璃、镜面不锈钢、发纹不锈钢
地板：PVC（可选大理石）

Ceiling: Mirror-finished stainless steel frame, acrylic translucent panel
Car wall: Art glass, mirror-finished stainless steel, hairline stainless steel
Floor: PVC (marble optional)



扫描二维码 观看轿厢
Scan the QR code watch the car

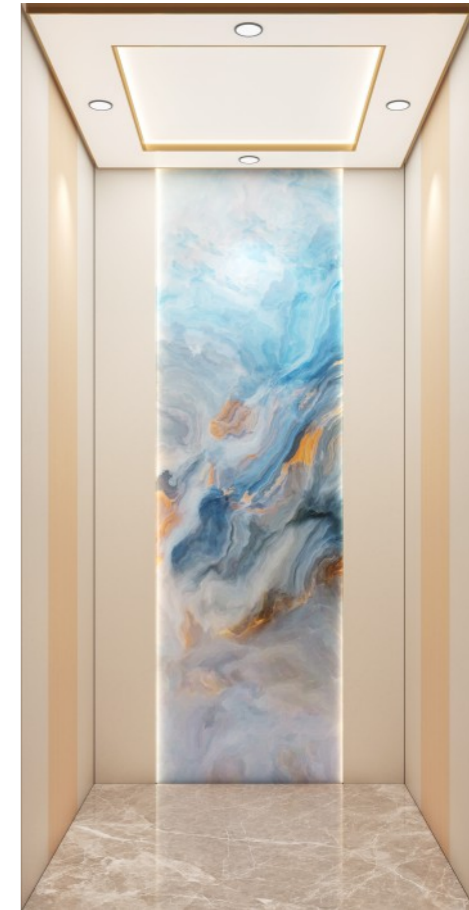

CON-NXH-41

选配/Optional

吊顶：正白艺术钢板、香槟金饰条、LED灯
轿壁：卡其白皮纹、艺术钢板、LED灯带、黄白橡艺术钢板
地板：PVC（可选大理石）

Ceiling: Pure white art steel plate, champagne gold trim, LED lights
Car wall: Khaki white leather grain, art steel plate, LED light strip, yellow-white oak art steel plate
Floor: PVC (marble optional)



扫描二维码 观看轿厢
Scan the QR code watch the car

CON-NXH-34

选配/Optional

吊顶：镜面不锈钢、亚克力透光板、LED筒灯
轿壁：镜面不锈钢、木纹钢板、发纹不锈钢
地板：PVC（可选大理石）

Ceiling: Mirror-finished stainless steel, acrylic translucent panel, LED downlights
Car wall: Mirror-finished stainless steel, wood grain steel plate, hairline stainless steel
Floor: PVC (marble optional)



扫描二维码 观看轿厢
Scan the QR code watch the car

CON-NXH-40

选配/Optional

吊顶：亚克力透光板、黑钛发纹包边
轿壁：卡其白皮纹艺术钢板、LED灯带、鱼肚白石纹艺术钢板
地板：PVC（可选大理石）

Ceiling: Acrylic translucent panel with black titanium hairline trim
Car wall: Khaki white leather grain art steel plate, LED light strip, fish-belly white stone grain art steel plate
Floor: PVC (marble optional)



扫描二维码 观看轿厢
Scan the QR code watch the car



AuraFlow[®]

Series



Passenger Elevator
乘客电梯系列

AuraFlow[®] Series

Passenger Elevator

乘客电梯系列

小机房乘客电梯

Small machine room passenger elevator

小机房乘客电梯采用高效节能低转速的永磁同步无齿轮曳引机，与同等载重量级别的有齿轮电梯相比，节约大部分能源。特殊设计的小体积控制柜结合最先进的低损耗IGBT和最佳设计方案，使机房空间得到完美的布置。

The small machine room passenger elevator adopts a high-efficiency, energy-saving and low-speed permanent magnet synchronous gearless traction machine, which saves most of the energy compared with geared elevators with the same load capacity. The specially designed small-volume control cabinet combines the most advanced low-loss IGBT and the best design scheme to perfectly arrange the space of the machine room.



应用场景

Applying fields



住宅
Residential



写字楼
Office building

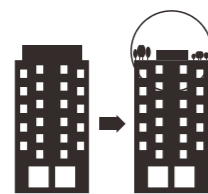

减少50%机房面积
Reduce machine room area by 50%

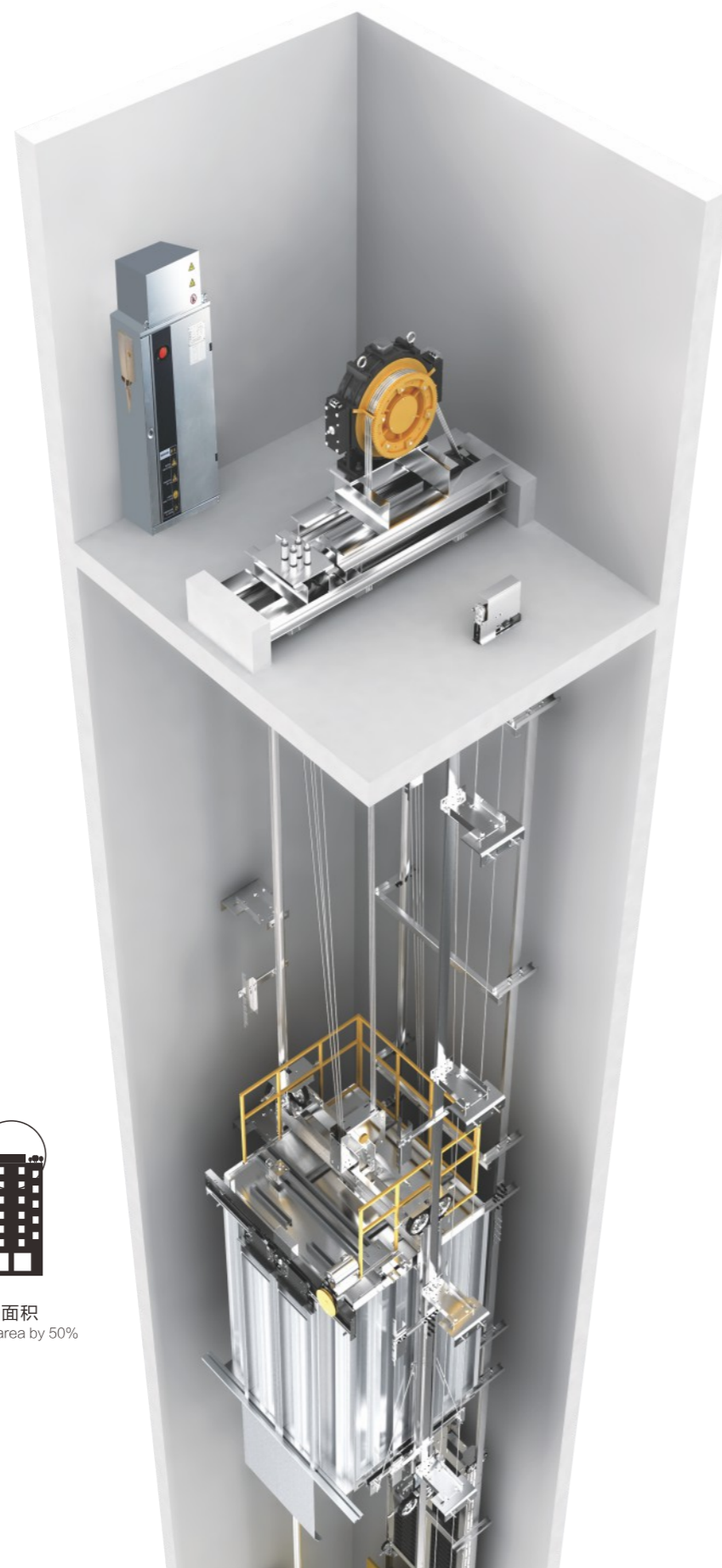

无机房乘客电梯

Machine roomless passenger elevator

采用无机房结构，将控制柜与曳引机灵活置于井道，节约建筑面积，造型美观简约，也为建筑师和开发商留有设计余地，降低了综合建筑成本。

With machine roomless structure, control cabinet and traction are placed in the shaft flexibly. It saves construction area and with artistic and simple shape, which reduces comprehensive construction cost and leaves design spece for architects and developers.



应用场景

Applying fields



住宅
Residential



商务楼
Business building

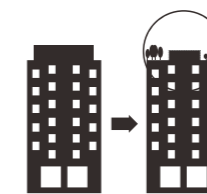

自由利用宝贵的建筑空间
Free use of precious architectural space



ENJOY THE EXPERIENCE WITH PEACE OF MIND

安心享受乘梯体验

永磁同步无齿轮曳引机开发了新一代节能电梯。其基于环保理念成功开发的核心技术代表了电梯未来的发展方向。节能、节省空间、降低建筑施工成本和电梯运营成本是这项领先行业的核心技术的最大特点。并且彻底解决了传统曳引机漏油造成的环境污染问题，满足了电机免维护、环保的要求。

The permanent magnet synchronous gearless traction machine has developed a new generation of energy-saving elevators. Its core technology successfully developed based on the concept of environmental protection represents the future development direction of elevators. Energy-saving, space-saving, lower building construction costs and elevator operating costs are the biggest features of this core technology leading the industry. And it completely solves the environmental pollution problem caused by the oil leakage of the traditional traction machine, and meets the maintenance-free and environmental protection requirements of the motor.

最高能源效率评级

Maximum energy efficiency rating

我们一直致力于研发更节能的电梯解决方案，帮助客户节约成本。我们的节能主要是通过三个途径：主机、电梯设备、控制系统。

We have been committed to researching and developing more energy-efficient elevator solutions to help customers save costs. Our energy saving is mainly through three ways: the host, car equipment, and control system.

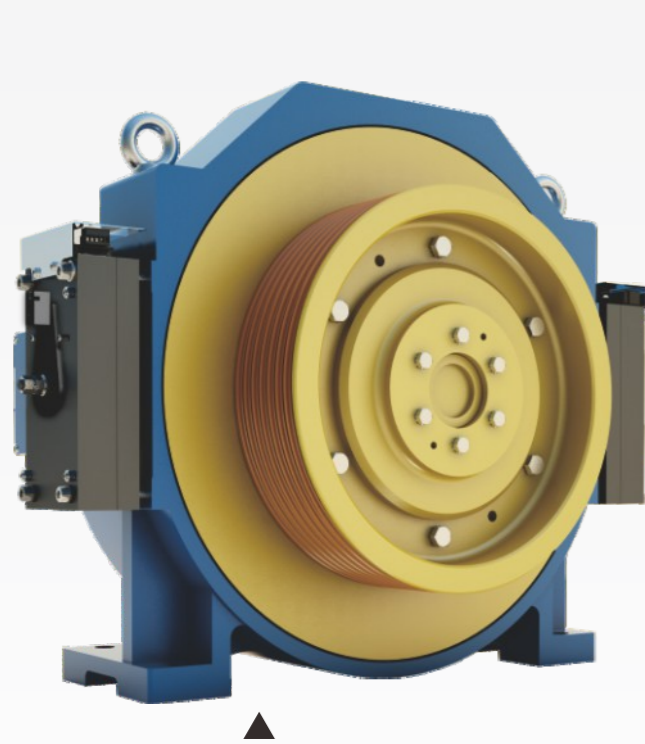
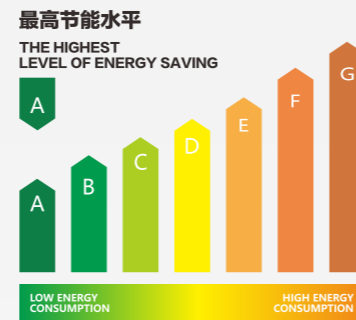

GEARLESS TRACTION MACHINE
无齿轮曳引机



光幕

Light curtain

全系列红外线幕防护屏障，有效监控电梯入口区域物体，安全性能高，进出更自由。

A full range of infrared light curtain protection barrier, effectively monitoring the elevator entrance area objects, safety performance is high, the more freedom to go in and out.

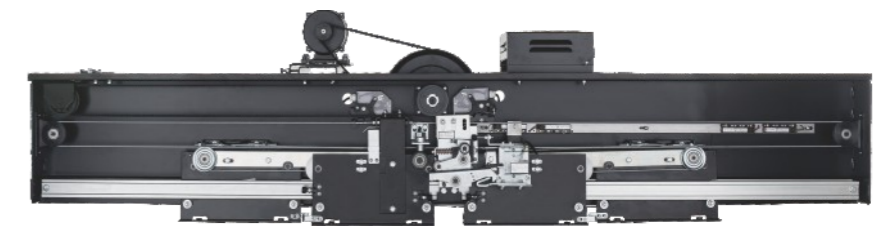

VVVF可变频率异步门机系统

VVVF variable frequency asynchronous door operator

CONIC电梯将先进的VVVF可变电压和频率控制技术应用于电梯门操作系统，确保电梯门的畅通和开关的安静。更重要的是，自学习门负载检测器提高了电梯门打开/关闭的灵敏度。它监控每个楼层电梯门负载的变化。自动调整各楼层最合适的开/关速度，保证安全性和可靠性。

CONIC elevator applies the advanced VVVF variable voltage and variable frequency control technology to the elevator door operator system so as to ensure the smooth elevator door and quiet switch. What is more, the self-learning door load detector increases the sensitivity of the elevator door switching on/off. It monitors the variation of elevator door load on every floor. Automatically rectifying the most appropriate open/shut speed in every floor so as to guarantee the security and reliability.



如果电梯超过标准限速，限速器就会动作并切断安全回路，确保电梯停止。如果电梯超过标准速度，安全钳通过限速器联动动作，从而确保电梯安全制动，并采用液压缓冲器。它能最大程度地吸收电梯异常冲击能量，从而保障广大乘客的安全。

采用最先进的节能技术，最大限度地减少运营过程中的能源消耗。经济耐用的运营模式，有效节省运营成本和维护成本。

If elevator exceeds standard speed limit, speed governor acts and cuts off safety loop to ensure elevator stop. If elevator exceeds standard speed, safety tongs acts through linkage of speed governor. It thus ensures elevator safety brake. It applies hydraulic buffer. It can absorb elevator abnormal impact energy to maximum degree. It thus guarantees safety of vast passengers.

Adopt the most advanced energy-saving technology to minimize energy consumption during operation. Economical and durable operation mode, which effectively saves operating costs and maintenance costs.

FULL COMMITMENT TO SAFETY

对安全的全面承诺

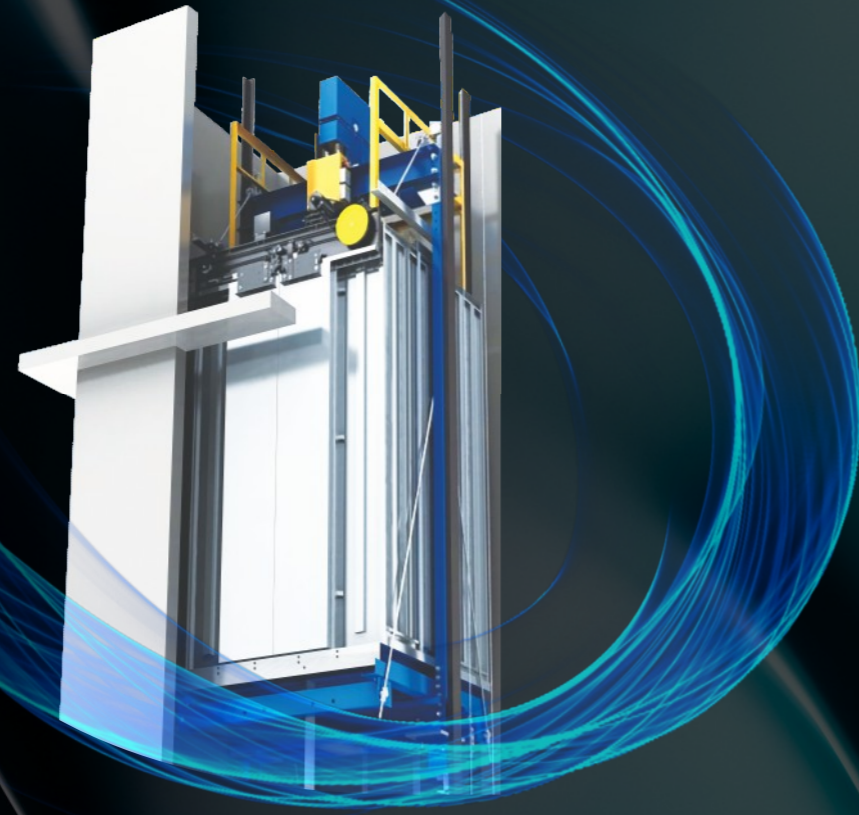

超级移位安全防护系统

Super stall safety protection system

当电梯发生超速、坠落等情况时，如果电接触器动作无法停止电梯，且速度达到一定值，则由限速器执行机械动作。它触发安全钳夹住轨道并制动电梯车厢。

When elevator over-speed, fall-down etc. take place, if electrical contactor action can not stop the elevator and speed attains certain value, speed governor then executes mechanical action. It triggers safety tongs to clamp the guiderail and brake the elevator car.

层站/轿门安全保护系统

Landing / car door safety protection system

如果在关门区域检测到任何障碍物，门就会再次重新打开。同时，层门和车厢门关闭后，电梯即可再次启动。各楼层所有门关闭后，电梯即可开始上下运动。

If it detects any obstacle at door-closing zone, door re-opens again. Meanwhile, after landing door and car door are closed, elevator can then start again. After all the doors at various floors are closed, elevator can start up / down motion.

电气安全保护系统

Electrical safety protection system

各种电梯安全保护系统的电气安全保护开关均串联。只需一次开关动作即可断开安全保护电路并停止电梯。

Electrical safety protection switches of various elevator safety protection system are of series connection. Only one switch action can break the safety protection circuit and stop the elevator.

防止机械损坏的安全性

Safety against mechanical damage

为了防止意外机械损坏，限速器等安全装置在附近设置警告标志和护栏。

In order to prevent from accidental mechanical damage, safety devices such as speed governor etc., set warning mark and guardrail at nearby places.

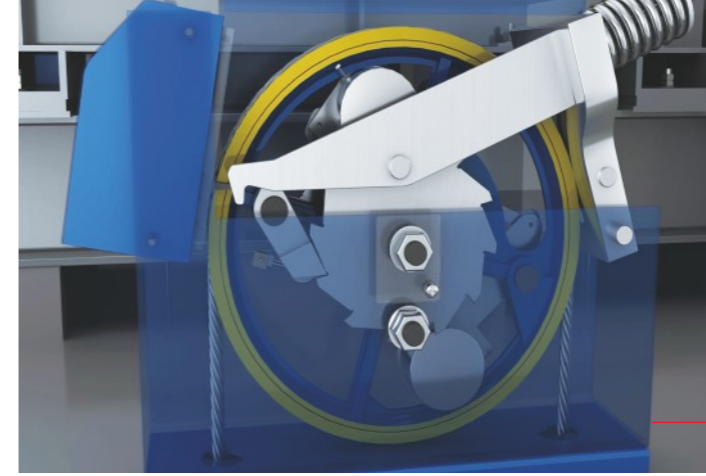

限速器

OVER SPEED GOVERNOR

当电梯超过标准极限速度时，限速器会切断安全电路，确保电梯停止运行，安全装置会机械抬起，将车厢停在轨道上。

When the elevator exceeds the standard limit speed, the speed limiter will cut off the safety circuit to ensure that the elevator stops running, and the safety gear will be lifted mechanically to stop the car on the guide rail.

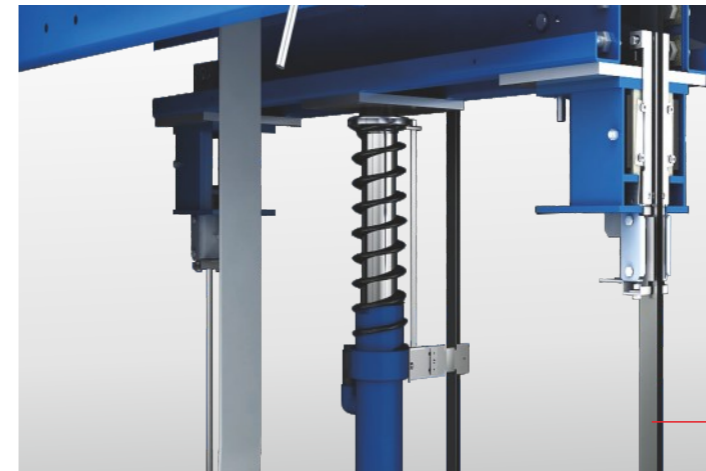

缓冲器

BUFFER

它可以最大程度地吸收电梯的异常冲击能量，确保电梯乘客的安全。

It can absorb the abnormal impact energy of the elevator to the greatest extent and ensure the safety of elevator passengers.

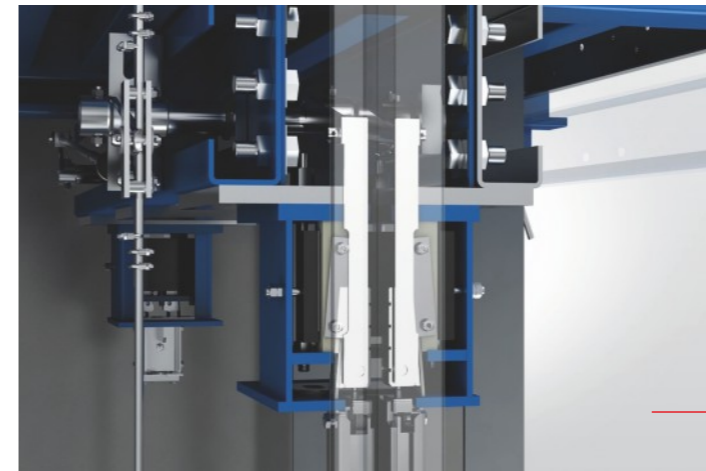

安全钳

SAFETY GEAR

当电梯超过标准速度时，安全装置由限速器的联动机构启动，确保电梯安全停止。

When the elevator exceeds the standard speed, the safety gear is actuated by the linkage of the speed limiter to ensure the safe stop of the elevator.



滚轮导轨

ROLLER GUIDE SHOES

采用滚动摩擦代替滑动摩擦，减少了摩擦损失，减少了运行时的振动和噪音，提高了乘坐舒适性。

Rolling friction is used instead of sliding friction, which reduces friction loss, reduces vibration and noise during operation, and improves ride comfort.

CONTROL CABINET

双32位智能全计算机控制系统

DUAL 32-BIT INTELLIGENT FULLCOMPUTER CONTROL SYSTEM

电梯控制系统是专门为电梯控制系统设计的集成产品。“一体化”控制技术适用于永磁同步电梯主机。简单来说，它集成了电梯逆变器和控制板，节省了电气元件和控制柜空间，降低了成本，同时控制了柜的运行和维护。相应地，事情变得简单。

The elevator control system is an integrated product designed specifically for elevator control systems. The "integrated" control technology is suitable for the permanent magnet synchronous elevator main engine. In simple terms, it integrates the elevator inverter and the control board, saving electrical components and control cabinet space, reducing costs, and at the same time controlling the operation and maintenance of the cabinet. Correspondingly, it becomes simple.

负载自适应系统

Load adaptive system

高达16 KHz的IGBTs开关频率和360°全封闭轿厢降噪设计，使乘客获得安静的乘坐体验。

The IGBT switching frequency of up to 16KHz and the 360° fully enclosed car noise reduction design enable passengers to obtain a quiet ride experience.

多重减震自适应系统 (>1.0m/s)

Multiple vibration reduction adaptive system (>1.0m/s)

主机、绳扣车、车顶、弹簧、橡胶等采用多重减震，为乘客带来完美的上下享受。

The main engine, rope fastening car, car top, spring and rubber are used for multiple vibration damping, which brings perfect up and down enjoyment to passengers.

顶级门机系统

Top-grade door machine system

高度集成的微型计算机网络控制系统立即完成数据操作。序列数据传输有序、准确地传输每一条消息。它增强了准确可靠的信号控制。

Highly integrated micro-computer network control system instantly finishes data operation. Serial data transmission orderly and accurately transmits every message. It enhances accurate and reliable signal control.

24小时远程监控 (付费选项)

24 hours remote monitoring (paid option)

通过无线通信模块，远程监控中心对电梯运行状态进行24小时实时监控，可实现自动故障报警、实时指导和故障排除，确保电梯快速恢复运行。

Through the wireless communication module, 24-hour live monitoring of the elevator operation status in the remote monitoring center can realize automatic fault alarm, real-time guidance and troubleshooting, and ensure that the elevator can resume operation quickly.

WISDOM CREATE THE FUTURE

智慧创造未来



AuraFlow[®] Series

Standard cabin design optional
标配轿厢设计可选

AIRLINE CAR



CON-AF-1

标配 Standard

吊顶：拉丝不锈钢，LED照明
轿壁：拉丝不锈钢
地板：PVC（可选大理石）

Ceiling: Hairline stainless steel, LED lighting
Cabin wall: Hairline stainless steel
Floor: PVC (marble optional)



发纹拉丝不锈钢
Hairline stainless steel
CON-DOR-H1



扫描二维码 观看轿厢
Scan the QR code
watch the car



CON-COP-1

304发纹不锈钢
304SS Hairline

COP面板尺寸：1370*180
安装尺寸：1330*155
COP faceplate size: 1370*180
install size: 1330*155



CON-LOP-1

304发纹不锈钢
304SS Hairline

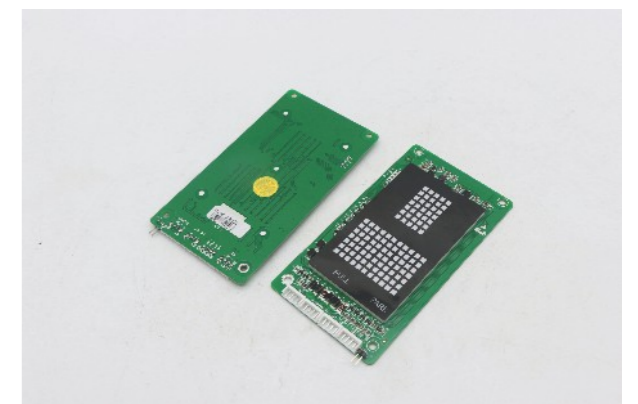
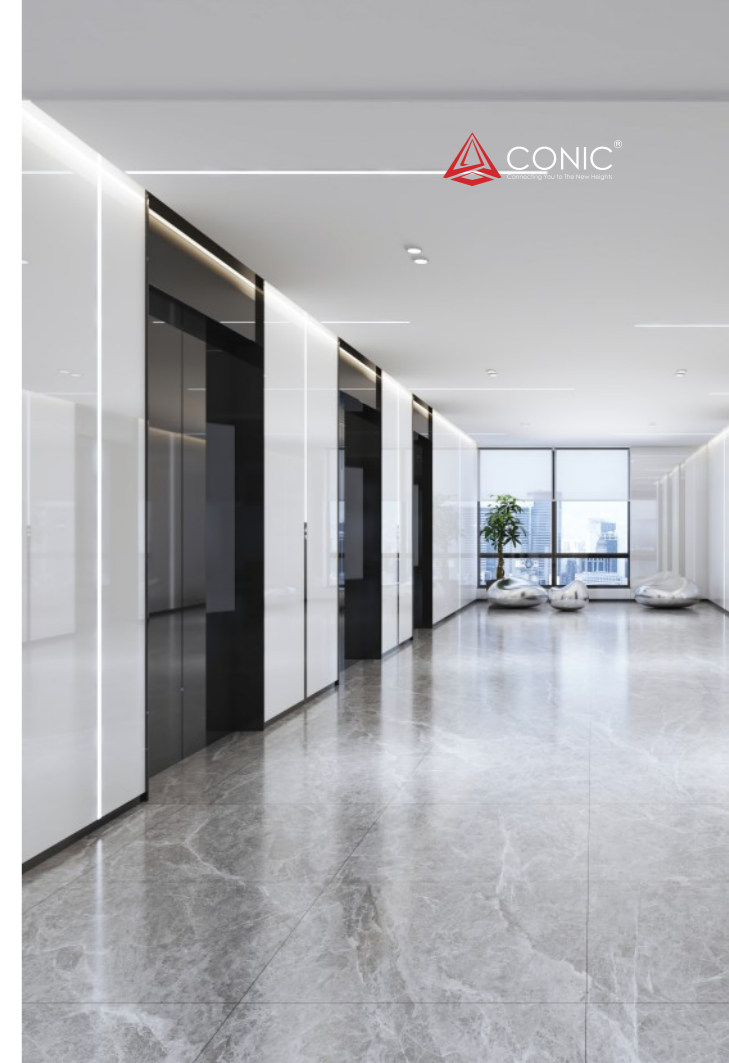

LOP display

LOP 显示：DOT 显示，可选红色、白色、橙色
LOP display : DOT display, red white orange optional

AuraFlow[®] Series

Standard cabin design optional
标配轿厢设计可选



CON-AF-2

选配 Optional

吊顶：镜框，透明灯柱，LED灯
轿壁：三面镜面蚀刻
地板：PVC（可选大理石）

Ceiling: Mirror frame, transparent lamp posts, LED lights
Cabin wall: Mirror etching on 3 sides
Floor: PVC (marble optional)



CON-COP-3

COP 304SS 发丝纹，LOP 304SS 镜面玻璃可选
COP 面板尺寸：1370*180，
安装尺寸：1330*155COP
显示屏：照片显示LOP
显示屏：点阵LCD显示可选

COP 304SS Hairline, LOP 304SS Mirror Glass optional
COP faceplate size: 1370*180, install size: 1330*155
COP display: Photo display
LOP display: DOT LCD display optional



扫描二维码 观看轿厢
Scan the QR code watch the car



CON-LOP-3



CON-LOP-4



CON-AF-3

选配/Optional

吊顶：发纹不锈钢，亚克力照明，LED灯
轿壁：发纹不锈钢，镜面不锈钢
地板：编织地板（可选大理石）

Ceiling: Brushed stainless steel, acrylic lighting, LED lights
Cabin wall: Brushed stainless steel, mirror stainless steel
Floor: Woven flooring (marble optional)



CON-AF-5

选配/Optional

吊顶：镜面不锈钢，亚克力照明，LED灯
轿壁：三面镜面蚀刻
地板：PVC（可选大理石）

Ceiling: Mirror stainless steel, acrylic lighting, LED lights
Cabin wall: Mirror etching on 3 sides
Floor: PVC (marble optional)

吊顶：亚克力照明
轿壁：三面镜面蚀刻
地板：PVC（可选大理石）

Ceiling: Acrylic lighting
Cabin wall: Mirror etching on 3 sides
Floor: PVC (marble optional)

吊顶：发纹不锈钢，亚克力照明，LED灯
轿壁：三面镜面蚀刻
地板：PVC（可选大理石）

Ceiling: Brushed stainless steel, acrylic lighting, LED lights
Cabin wall: Mirror etching on 3 sides
Floor: PVC (marble optional)



CON-AF-4

选配/Optional



CON-AF-6

选配/Optional

STANDARD CABIN DESIGN OPTIONAL



吊顶：镜面不锈钢，亚克力照明，LED灯
轿壁：三面镜面蚀刻
地板：PVC（可选大理石）

Ceiling: Mirror stainless steel, acrylic lighting, LED lights
Cabin wall: Mirror etching on 3 sides
Floor: PVC (marble optional)

吊顶：镜面不锈钢，亚克力照明，LED灯
轿壁：三面镜面蚀刻
地板：PVC（可选大理石）

Ceiling: Mirror stainless steel frame, acrylic lighting, LED lights
Cabin wall: Mirror etching on 3 sides
Floor: PVC (marble optional)



CON-AF-8

选配/Optional



吊顶：发纹不锈钢，亚克力照明，LED灯
轿壁：三面镜面蚀刻
地板：PVC（可选大理石）

Ceiling: Hairline stainless steel, acrylic lighting, LED lights
Cabin wall: Mirror etching on 3 sides
Floor: PVC (marble optional)

吊顶：镜面不锈钢，亚克力照明，LED灯
轿壁：三面镜面蚀刻
地板：PVC（可选大理石）

Ceiling: Mirror stainless steel frame, acrylic lighting, LED lights
Cabin wall: Mirror etching on 3 sides
Floor: PVC (marble optional)



CON-AF-12

选配/Optional



吊顶：发纹不锈钢，亚克力照明，LED灯
轿壁：三面镜面蚀刻
地板：PVC（可选大理石）

Ceiling: Hairline stainless steel frame, acrylic lighting, LED lights
Cabin wall: Mirror etching on 3 sides
Floor: PVC (marble optional)

吊顶：镜面不锈钢，亚克力照明，LED灯
轿壁：三面镜面蚀刻
地板：PVC（可选大理石）

Ceiling: Mirror stainless steel frame, acrylic lighting, LED lights
Cabin wall: Mirror etching on 3 sides
Floor: PVC (marble optional)



CON-AF-10

选配/Optional



吊顶：发纹不锈钢，亚克力照明，LED灯
轿壁：三面镜面蚀刻
地板：PVC（可选大理石）

Ceiling: Hairline stainless steel frame, acrylic lighting, LED lights
Cabin wall: Mirror etching on 3 sides
Floor: PVC (marble optional)

吊顶：发纹不锈钢，亚克力照明，LED灯
轿壁：三面镜面蚀刻
地板：PVC（可选大理石）

Ceiling: Hairline stainless steel frame, acrylic lighting, LED lights
Cabin wall: Mirror etching on 3 sides
Floor: PVC (marble optional)

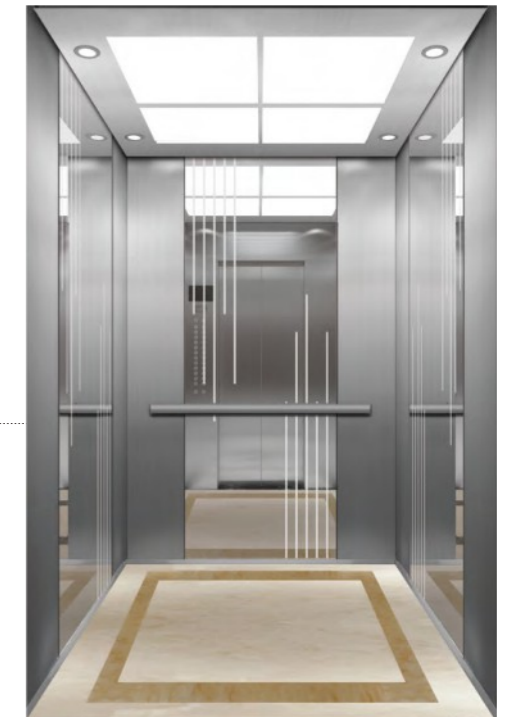

CON-AF-14

选配/Optional

CON-AF-9

选配/Optional

CON-AF-13

选配/Optional

PREMIUM CABIN DESIGN OPTIONAL

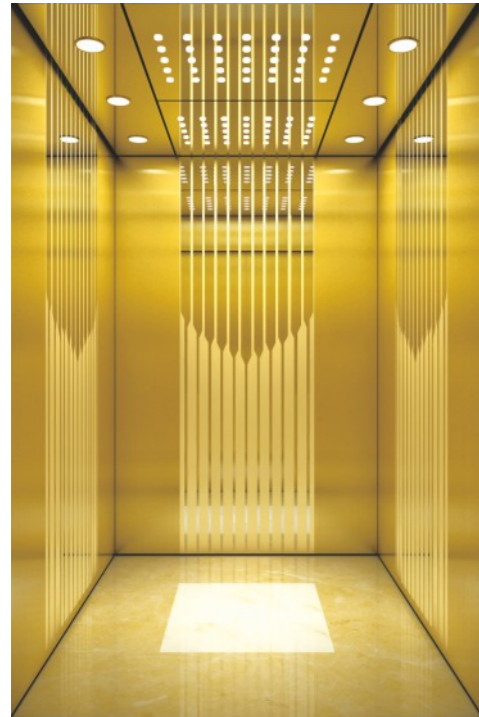

吊顶：钛金镜面不锈钢，亚克力照明，LED灯
轿壁：三面镜面蚀刻
地板：PVC（可选大理石）

Ceiling: Titanium mirror frame, acrylic lighting, LED lights
Cabin wall: Three-sided titanium mirror etching
Floor: PVC (marble optional)

吊顶：钛金镜面不锈钢，亚克力照明，LED灯
轿壁：三面镜面蚀刻
地板：PVC（可选大理石）

Ceiling: Titanium mirror frame, acrylic lighting, LED lights
Cabin wall: Three-sided titanium mirror etching
Floor: PVC (marble optional)

CON-AF-15

选配/Optional



CON-AF-16

选配/Optional



CON-AF-19

选配/Optional



CON-AF-20

选配/Optional



吊顶：钛金发纹不锈钢，亚克力照明，LED灯
轿壁：三面镜面蚀刻
地板：PVC（可选大理石）

Ceiling: Titanium hairline stainless steel frame, acrylic lighting, LED lights
Cabin wall: Three-sided titanium mirror etching
Floor: PVC (marble optional)

吊顶：钛金发纹不锈钢，亚克力照明，LED灯
轿壁：三面镜面蚀刻
地板：PVC（可选大理石）

Ceiling: Titanium hairline stainless steel frame, acrylic lighting, LED lights
Cabin wall: Three-sided titanium mirror etching
Floor: PVC (marble optional)

CON-AF-17

选配/Optional



CON-AF-18

选配/Optional

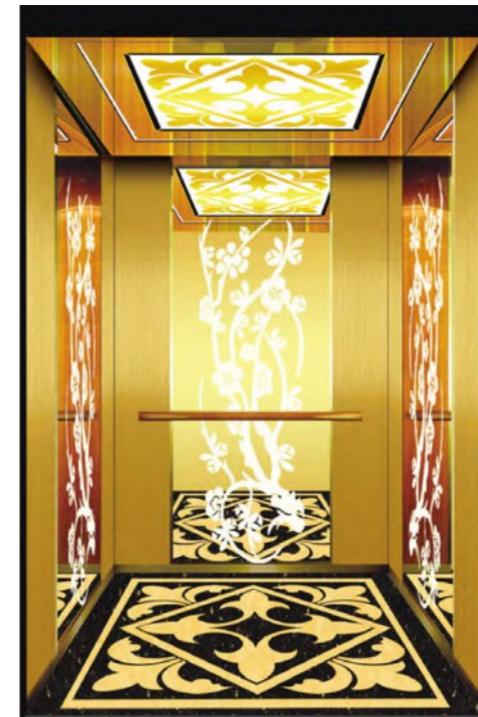

CON-AF-21

选配/Optional

吊顶：钛金镜面不锈钢，亚克力照明，LED灯
轿壁：三面镜面蚀刻
地板：PVC（可选大理石）

Ceiling: Titanium mirror frame, acrylic lighting, LED lights
Cabin wall: Three-sided titanium mirror etching
Floor: PVC (marble optional)

吊顶：钛金镜面不锈钢，亚克力照明，LED灯
轿壁：三面镜面蚀刻
地板：PVC（可选大理石）

Ceiling: Titanium mirror frame, acrylic lighting, LED lights
Cabin wall: Three-sided titanium mirror etching
Floor: PVC (marble optional)

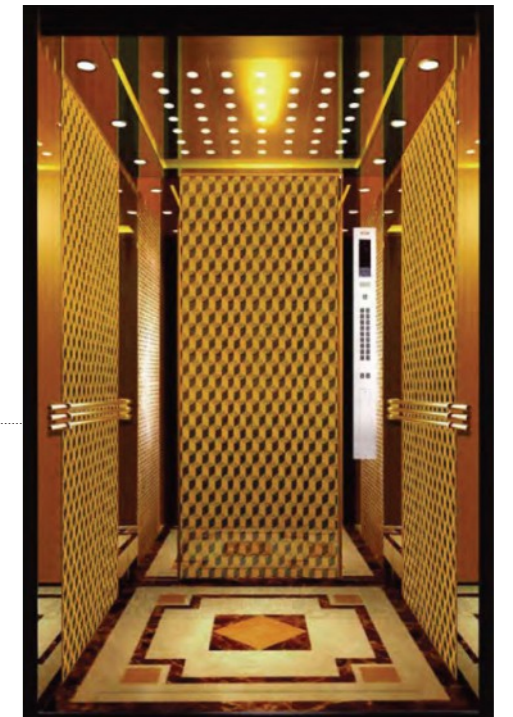

CON-AF-22

选配/Optional

ULTRA PREMIUM CABIN DESIGN OPTIONAL



吊顶：镜面不锈钢，亚克力照明，LED灯
轿壁：三面玫瑰金镜面蚀刻
地板：PVC（可选大理石）

Ceiling: Mirror stainless steel frame, acrylic transparent plate, LED lights
Cabin wall: Mirror etching of rose gold on three sides
Floor: PVC (marble optional)

吊顶：玫瑰金镜面不锈钢，亚克力照明，LED灯
轿壁：三面玫瑰金镜面蚀刻
地板：PVC（可选大理石）

Ceiling: Roes gold mirror frame, acrylic lighting, LED lights
Cabin wall: Mirror etching of rose gold on three sides
Floor: PVC (marble optional)

CON-AF-23

选配/Optional



CON-AF-24

选配/Optional

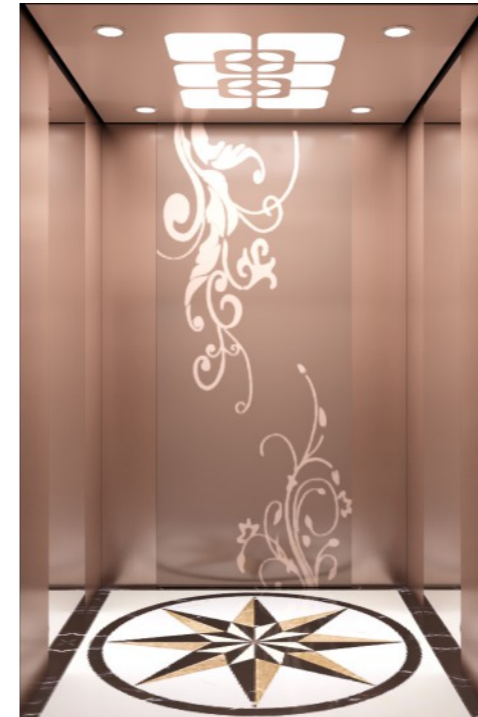

吊顶：玫瑰金发纹不锈钢，亚克力照明，LED灯
轿壁：玫瑰金镜面不锈钢，镜面蚀刻
地板：PVC（可选大理石）

Ceiling: Rose gold hairline stainless steel frame, acrylic lighting, LED lights
Cabin wall: Rose gold mirror stainless steel, mirror etching
Floor: PVC (marble optional)

吊顶：玫瑰金镜面不锈钢，亚克力照明，LED灯
轿壁：三面玫瑰金镜面蚀刻
地板：PVC（可选大理石）

Car roof: Roes gold stainless steel frame, LED lights
Cabin wall: Mirror etching of rose gold on three sides
Floor: PVC (marble optional)

CON-AF-27

选配/Optional



CON-AF-28

选配/Optional

选配/Optional



吊顶：玫瑰金发纹不锈钢，亚克力照明，LED灯
轿壁：三面玫瑰金镜面蚀刻
地板：PVC（可选大理石）

Ceiling: Rose gold hairline stainless steel frame, acrylic lighting, LED lights
Cabin wall: Mirror etching of rose gold on three sides
Floor: PVC (marble optional)

吊顶：玫瑰金镜面不锈钢，亚克力照明，LED灯
轿壁：三面玫瑰金镜面蚀刻
地板：PVC（可选大理石）

Ceiling: Roes gold mirror frame, acrylic lighting, LED lights
Cabin wall: Mirror etching of rose gold on three sides
Floor: PVC (marble optional)

CON-AF-25

选配/Optional



CON-AF-26

选配/Optional

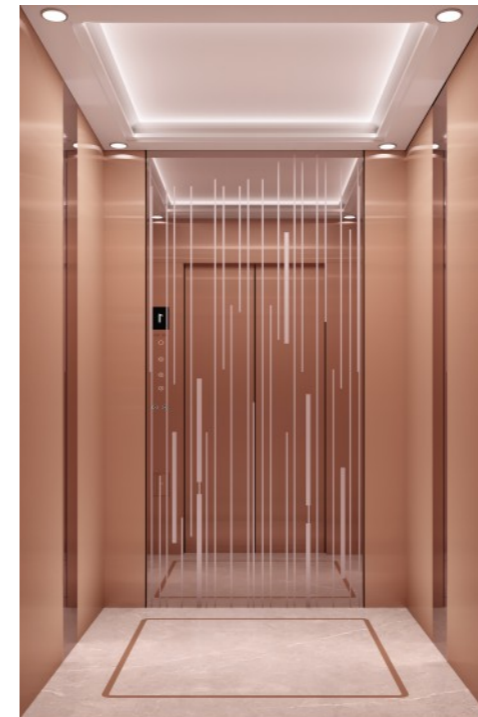

吊顶：钢板喷涂，隐藏灯带，LED灯
轿壁：玫瑰金镜面不锈钢，镜面蚀刻
地板：PVC（可选大理石）

Ceiling: Steel plate spraying, hidden light strip, LED light
Cabin wall: Rose gold mirror stainless steel, mirror etching
Floor: PVC (marble optional)

吊顶：玫瑰金发纹不锈钢，亚克力照明
轿壁：玫瑰金镜面不锈钢，镜面蚀刻
地板：PVC（可选大理石）

Ceiling: Roes gold stainless steel frame, acrylic lighting
Cabin wall: Rose gold mirror stainless steel, mirror etching
Floor: PVC (marble optional)

CON-AF-29

选配/Optional

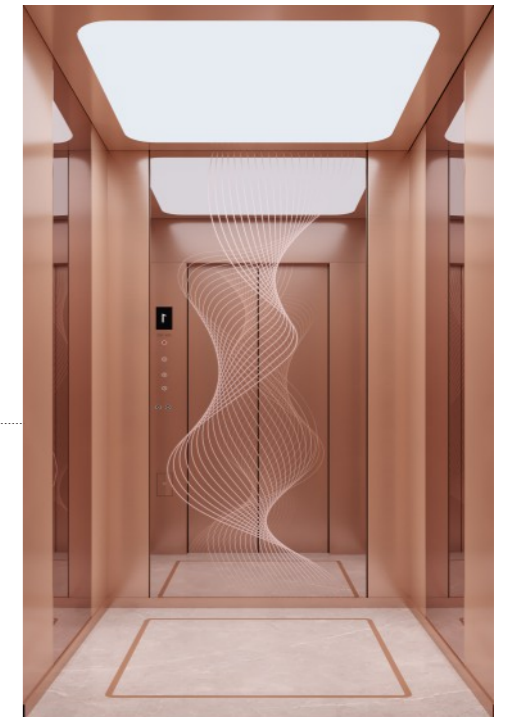

CON-AF-30

选配/Optional



AuraFlow[®] Series

High end cabin design optional
 高端轿厢设计选配



CON-AF-31

选配 Optional

吊顶：黑色钛镜面不锈钢，亚克力灯光
 轿壁：黑色钛镜面不锈钢
 地板：PVC（可选大理石）

Ceiling: Black titanium mirror frame, acrylic lighting
 Cabin wall: Black titanium mirror etching
 Floor: PVC (marble optional)



CON-COP-F1



扫描二维码 观看轿厢
 Scan the QR code watch the car



CON-LOP-3



CON-LOP-4

COP 304SS 镜面, LOP 304SS 镜面玻璃可选
 COP 面板尺寸: 1370*180,
 安装尺寸: 1330*155COP
 显示: 图片显示LOP 显示: 点阵液晶显示可选

COP 304SS Mirror, LOP 304SS Mirror Glass optional
 COP faceplate size: 1370*180, install size: 1330*155
 COP display: Photo display
 LOP display: DOT LCD display optional



吊顶：喷涂钢板，亚克力照明，LED灯
 轿壁：镜面不锈钢，木纹钢板
 地板：PVC（可选大理石）

Ceiling: Sprayed steel plate, acrylic lighting, LED lights
 Cabin wall: Mirror stainless steel, wood grain steel plate
 Floor: PVC (marble optional)

CON-AF-32

选配/Optional

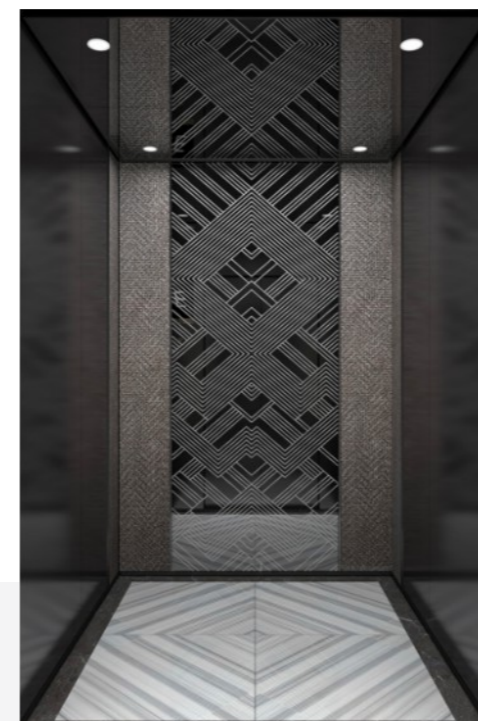

吊顶：黑色钛金镜面不锈钢，LED灯
 轿壁：黑色钛金镜面蚀刻
 地板：PVC（可选大理石）

Ceiling: Black titanium mirror frame, LED lights
 Cabin wall: Black titanium mirror etching
 Floor: PVC (marble optional)

CON-AF-34

选配/Optional

吊顶：发纹深灰不锈钢，LV老花不锈钢，LED灯
 轿壁：发纹深灰不锈钢，LV老花不锈钢黑檀木彩纹钢板
 地板：PVC（可选大理石）

Ceiling: Brushed dark gray stainless steel, LV monogram stainless steel, LED lights
 Cabin wall: Brushed dark gray stainless steel, LV monogram stainless steel ebony wood patterned steel plate
 Floor: PVC (marble optional)



吊顶：发纹不锈钢，亚克力照明
 轿壁：发纹不锈钢，喷涂钢板
 地板：PVC（可选大理石）

Car roof: Hairline stainless steel, acrylic lighting
 Cabin wall: Hairline stainless steel, sprayed steel plate
 Floor: PVC (marble optional)

CON-AF-33

选配/Optional



吊顶：发纹深灰不锈钢，LV老花不锈钢，LED灯
 轿壁：发纹深灰不锈钢，LV老花不锈钢黑檀木彩纹钢板
 地板：PVC（可选大理石）

Ceiling: Brushed dark gray stainless steel, LV monogram stainless steel, LED lights
 Cabin wall: Brushed dark gray stainless steel, LV monogram stainless steel ebony wood patterned steel plate
 Floor: PVC (marble optional)

CON-AF-35

选配/Optional



AuraFlow[®] Series

Modern cabin design optional

现代轿厢设计

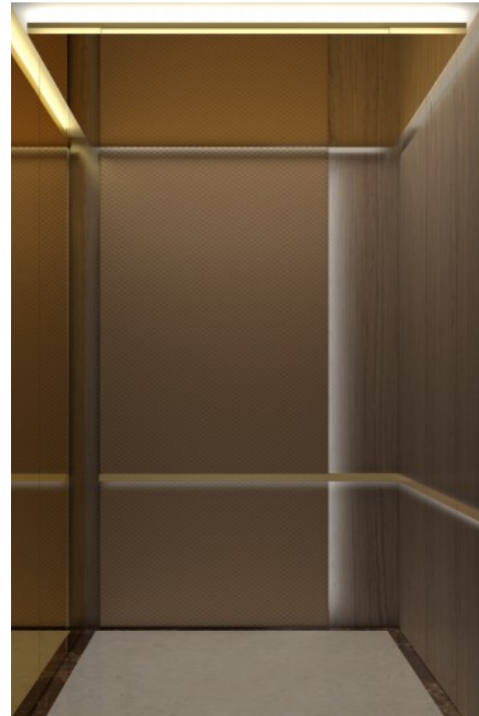

吊顶：镜面不锈钢，亚克力照明
轿壁：镜面蚀刻，老花不锈钢，木纹钢板
地板：PVC（可选大理石）

Ceiling: Mirror stainless steel frame, acrylic lighting
Cabin wall: Mirror etching, brushed stainless steel, wood grain steel plate
Floor: PVC (marble optional)

吊顶：镜面不锈钢，亚克力照明，LED灯
轿壁：三面镜面蚀刻
地板：PVC（可选大理石）

Ceiling: Mirror stainless steel frame, acrylic lighting, LED lights
Cabin wall: Mirror etching on 3 sides
Floor: PVC (marble optional)

CON-AF-36

选配/Optional



CON-AF-37

选配/Optional

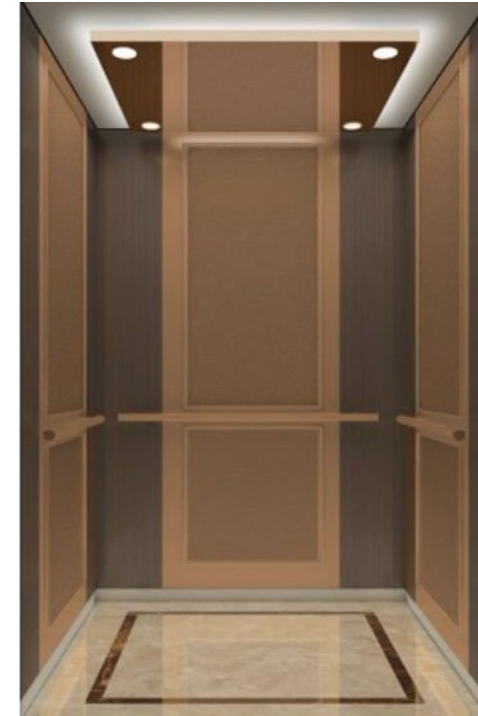

吊顶：发纹不锈钢，玫瑰金镜面，LED灯
轿壁：木纹钢板，玫瑰金不锈钢
地板：PVC（可选大理石）

Ceiling: Hairline stainless steel frame, rose gold mirror, LED light
Cabin wall: Wood-grain steel plate, rose gold stainless steel
Floor: PVC (marble optional)

吊顶：镜面不锈钢，亚克力照明，LED灯
轿壁：镜面不锈钢，木纹钢板
地板：PVC（可选大理石）

Ceiling: Mirror stainless steel frame, acrylic lighting, LED lights
Cabin wall: Mirror stainless steel, wood grain steel plate
Floor: PVC (marble optional)

CON-AF-40

选配/Optional



CON-AF-41

选配/Optional



吊顶：发纹不锈钢，亚克力照明，LED灯
轿壁：三面镜面蚀刻
地板：PVC（可选大理石）

Ceiling: Hairline stainless steel frame, acrylic lighting, LED lights
Cabin wall: Mirror etching on 3 sides
Floor: PVC (marble optional)

吊顶：中间是柔和的照明设计，带有拱形白色有机透光板
轿壁：三面镜面蚀刻
地板：PVC（可选大理石）

Ceiling: The middle part is a soft lighting design with arched white organic light-transmitting panels
Cabin wall: Mirror etching on 3 sides
Floor: PVC (marble optional)

CON-AF-38

选配/Optional



CON-AF-39

选配/Optional



吊顶：发纹不锈钢，亚克力照明，LED灯
轿壁：镜面不锈钢，木纹钢板
地板：PVC（可选大理石）

Ceiling: Hairline stainless steel frame, acrylic lighting, LED lights
Cabin wall: Mirror stainless steel, wood grain steel plate
Floor: PVC (marble optional)

吊顶：喷涂钢板，亚克力照明
轿壁：黑钛镜面不锈钢，木纹钢板
地板：PVC（可选大理石）

Ceiling: Spray-painted steel plate, acrylic lighting
Cabin wall: Black titanium stainless steel, wood grain steel plate
Floor: PVC (marble optional)

CON-AF-42

选配/Optional

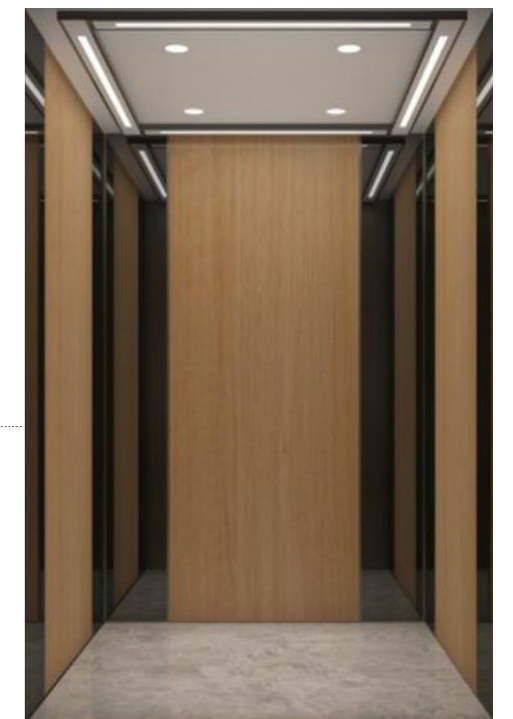

CON-AF-43

选配/Optional

安静稳定，视觉盛宴

Quiet and stable, visual feast

观光电梯设计精美，性能良好，是人工智能的完美融合。可靠舒适的内在品质与精致的视觉美相协调。它与建筑和周边环境融为一体，营造出美丽的动态景观，享受现代城市风格。在享受建筑之美的同时，享受流动空间的舒适，广泛应用于高端购物中心、酒店、办公楼等高端场所。

The observation elevators are beautifully designed and perform well, making them the perfect blend of artificial intelligence. The reliable and comfortable inner quality is harmonious with the exquisite visual beauty. It is integrated with the building and the surrounding environment to create a beautiful dynamic landscape and enjoy the modern urban style. While enjoying the beauty of the building, enjoy the comfort of the flowing space, widely used in high-end shopping malls, hotels, office buildings and other high-end places.

不同的开门方式

Different ways to open the door

时尚大方的设计风格可供顾客选择，蓝色显示部分为观光玻璃。

The stylish and generous design style is available for customers to choose from, and the blue display part is for sightseeing glass.

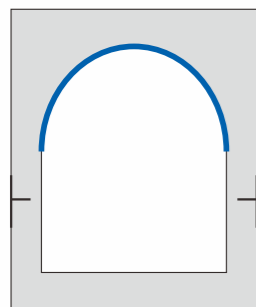

半圆形
Semi-circular
shaped

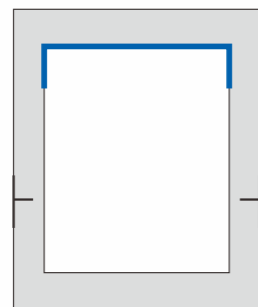

方形
Square shaped

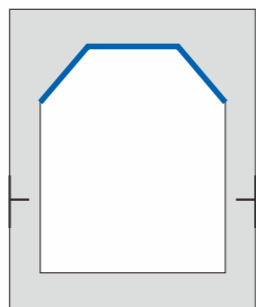

菱形
Cutting-angle-type

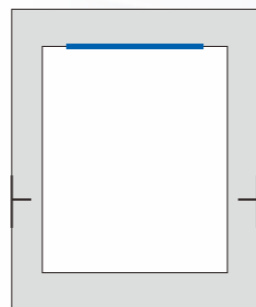

全观光
Panoramic

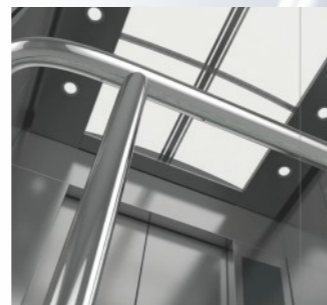
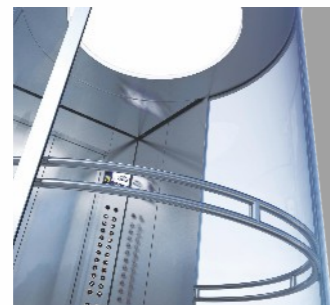

SkyLucid® Series
Observation Elevator Series
观光电梯系列

SkyLucid® Series

Observation Elevator Decoration Series

观光电梯装潢系列



CON-SL-1

选配/Optional



上下罩：镜面不锈钢
 观光墙：6+6安全夹层玻璃
 装饰面：镜面不锈钢，亚克力顶板
 轿壁：镜面不锈钢
 轿门：镶框玻璃门
 扶手：不锈钢双管
 地板：PVC（可选大理石）

Upper and lower covers: Mirror stainless steel
 Sightseeing wall: 6+6 safety laminated glass
 Decorative top: Mirror stainless steel, acrylic top plate
 Car wall: Mirror stainless steel
 Car door: Framed glass door
 Armrest: Stainless steel single tube
 Floor: PVC (optional marble)



CON-SL-2

选配/Optional



上下罩：发纹不锈钢
 观光墙：安全夹层玻璃
 装饰面：发纹不锈钢，中间乳白色，丙烯酸照明
 轿壁：发纹不锈钢
 轿门：发纹不锈钢
 扶手：不锈钢双管
 地板：PVC（可选大理石）

Upper and lower covers: Hairline stainless steel
 Sightseeing wall: Safety laminated glass
 Decorative top: Hairline stainless steel, milky white in the middle, acrylic lighting
 Car wall: Hairline stainless steel
 Car door: Hairline stainless steel
 Armrest: Stainless steel double tube
 Floor: PVC (optional marble)



CON-SL-3

选配/Optional

上下罩：发纹不锈钢
 观光墙：安全胶玻璃
 装饰面：发纹不锈钢，中间乳白色，丙烯酸灯光
 轿壁：发纹不锈钢
 轿门：发纹不锈钢
 扶手：不锈钢双管
 地板：PVC（可选大理石）

Upper and lower covers: hairline stainless steel
 Sightseeing wall: safety glue glass
 Decorative surface: hairline stainless steel, milky white in the middle, acrylic lighting
 Car wall: hairline stainless steel
 Car door: hairline stainless steel
 Handrails: Stainless steel double pipes
 Floor: PVC (optional marble)



CON-SL-4

选配/Optional

上下罩：钢板烤漆
 观光墙：安全胶玻璃
 装饰面：超薄软膜，LED
 轿壁：发纹不锈钢
 轿门：发纹不锈钢
 扶手：不锈钢管
 地板：PVC（可选大理石）

Upper and lower covers: steel plate paint
 Sightseeing wall: safety glue glass
 Decorative surface: Ultra-thin soft film, LED
 Car wall: hairline stainless steel
 Car door: hairline stainless steel
 Handrails: Stainless steel pipes
 Floor: PVC (optional marble)



CON-SL-5

选配/Optional

上下罩：钢板喷涂加装饰灯条
 观光墙：安全胶玻璃
 装饰面：拱形天花板、LED灯
 轿壁：发纹不锈钢
 轿门：发纹不锈钢
 扶手：不锈钢管
 地板：PVC（可选大理石）

Upper and lower covers: steel plate spraying and decorative light strips
 Sightseeing wall: safety glue glass
 Decorative surface: arched ceiling, LED lights
 Car wall: hairline stainless steel
 Car door: hairline stainless steel
 Handrails: Stainless steel pipes
 Floor: PVC (optional marble)



CON-SL-6

选配/Optional

上下罩：钛金发纹不锈钢
 观光墙：安全夹层玻璃
 装饰面：钛金发纹不锈钢，亚克力透光板
 轿壁：钛金发纹不锈钢
 轿门：钛金发纹不锈钢
 扶手：钛金圆扶手
 地板：PVC（可选大理石）

Upper and lower covers: titanium blond stainless steel
 Sightseeing wall: safety laminated glass
 Decorative surface: titanium blond stainless steel, acrylic transparent plate
 Car wall: titanium blond stainless steel
 Car door: titanium blond stainless steel
 Handrails: Titanium round handrail
 Floor: PVC (optional marble)

Elevator COP & HOP

电梯人机界面



CON-COP-F1

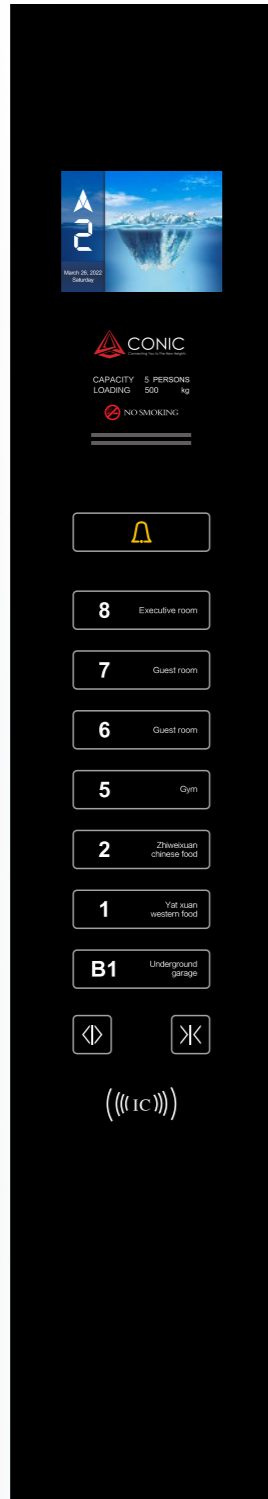

CON-COP-F2

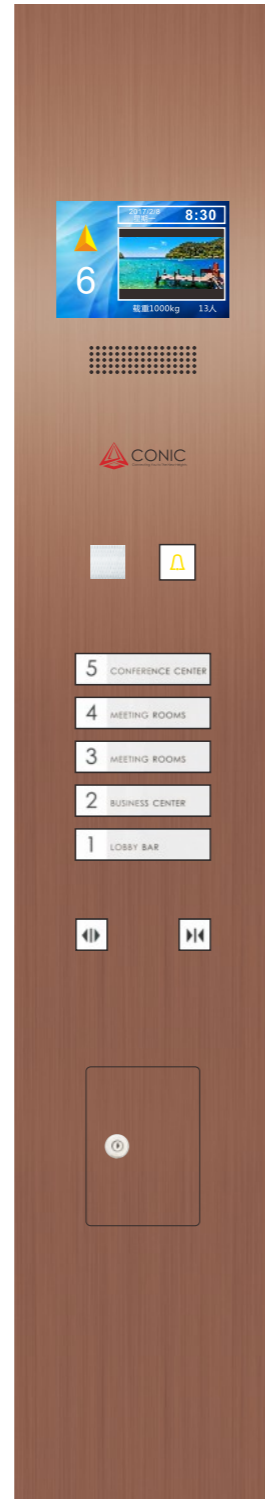

CON-COP-B2



CON-COP-B3

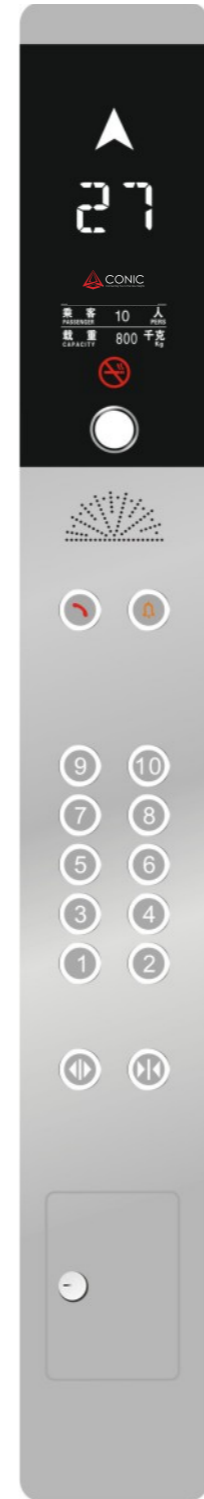

CON-COP-B4



CON-COP-B5

显示可选 Display optional

10.4 / 8 / 7 Inch TFT Photo Display With Voice, can customized theme picture;
10.4/8/7英寸TFT照片显示屏带语音, 可定制主题图片;

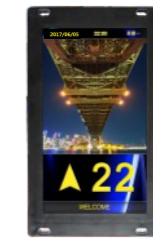

GNL-TFT7-PH-N3K

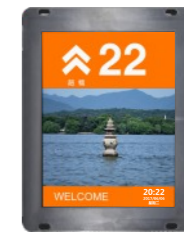

GNL-TFT8-PH-N3K



GNL-TFT104-PH-N3K

6.4/4.3英寸蓝色/黑色背景LCD显示屏
6.4 / 4.3 Inch Blue/Black background LCD Display

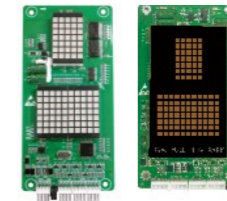

4.3英寸点阵显示屏
4.3 Inch dot display



4.3 Inch Fixed color LCD



4.3英寸固定彩色LCD

4.3 Inch HD Display



4.3英寸高清显示屏

按钮可选 Button optional



Elevator COP & HOP

电梯人机界面

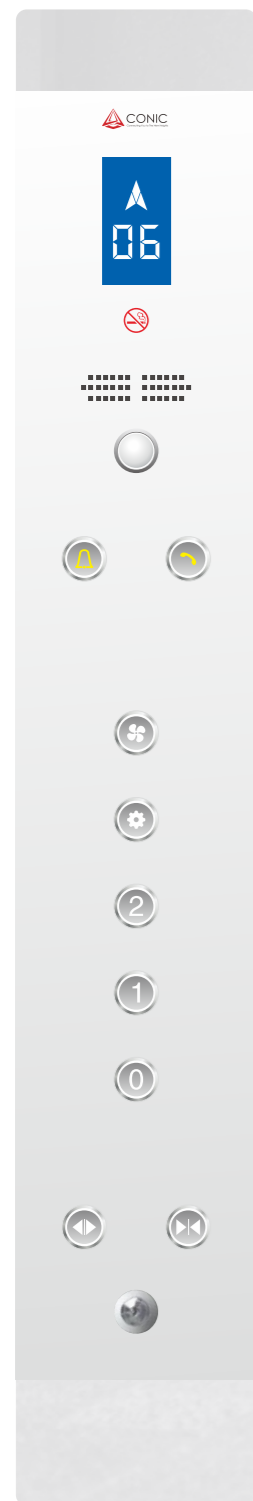

CON-COP-W1

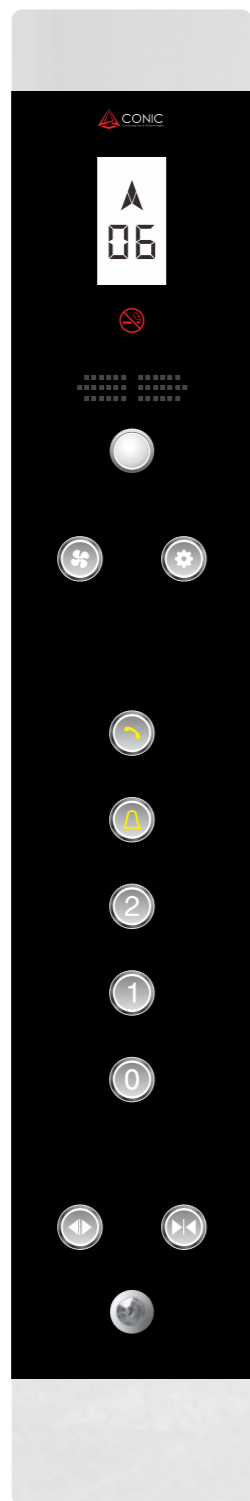

CON-COP-W2

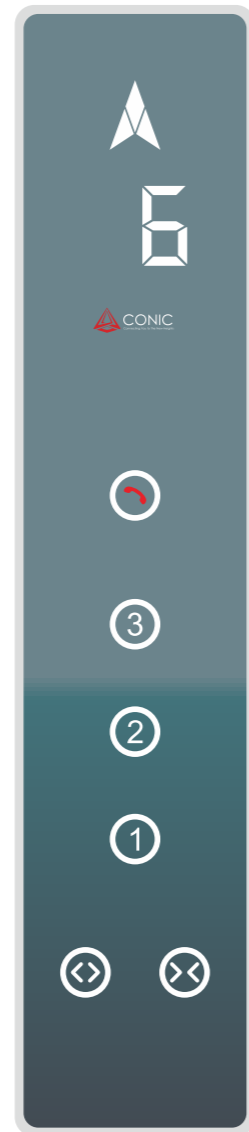

CON-COP-W3

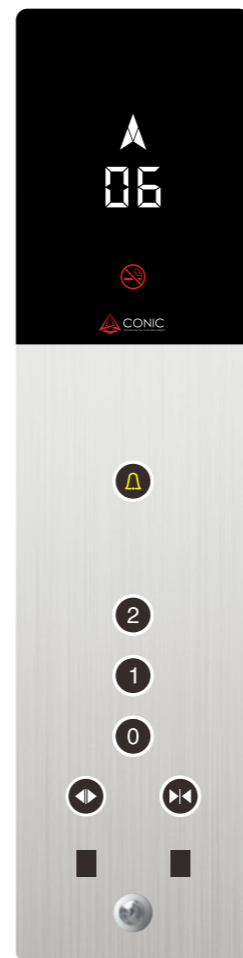

CON-COP-W4



CON-LOP-W1



CON-LOP-W2



CON-LOP-W3



CON-LOP-W4



CON-LOP-W5

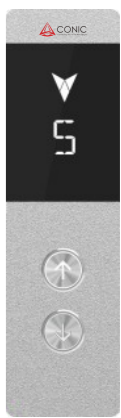

CON-LOP-W6



CON-LOP-W7



CON-LOP-W8



CON-LOP-W9



CON-LOP-W10



CON-LOP-W11



CON-LOP-W12



CON-LOP-W13



CON-LOP-W14



CON-LOP-W15

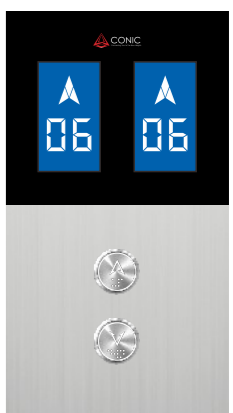

CON-LOP-W16

Ceiling Series

吊顶系列



CON-E01

镜面不锈钢框架, 亚克力透明板, LED灯
Mirror stainless steel frame, acrylic transparent plate, LED light



CON-E02

镜面不锈钢框架, 亚克力透明板, LED灯
Mirror stainless steel frame, acrylic transparent plate, LED light

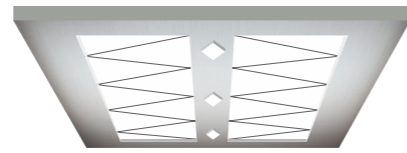

CON-E03

镜面不锈钢框架, 亚克力透明板, LED灯
Mirror stainless steel frame, acrylic transparent plate, LED light



CON-E04

镜面不锈钢框架, 亚克力透明板, LED灯
Mirror stainless steel frame, acrylic transparent plate, LED light



CON-E05

镜面不锈钢框架, 亚克力透明板, LED灯
Mirror stainless steel frame, acrylic transparent plate, LED light



CON-E06

镜面不锈钢框架, 亚克力透明板, LED灯
Mirror stainless steel frame, acrylic transparent plate, LED light

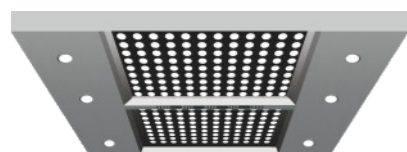

CON-E07

镜面不锈钢框架, 亚克力透明板, LED灯
Mirror stainless steel frame, acrylic transparent plate, LED light



CON-E08

黑钛不锈钢框架, 亚克力透明板, LED灯
Black titanium stainless steel frame, acrylic transparent plate, LED light



CON-E09

镜面不锈钢框架, 亚克力透明板
Mirror stainless steel frame, acrylic transparent plate

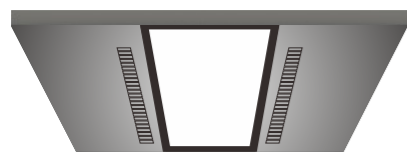

CON-E10

钻石银漆钢配亚克力板
Diamond silver lacquer steel with acrylic plate

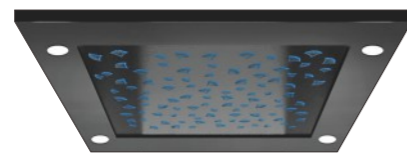

CON-E11

黑钛不锈钢框架, 顶部面板LED照明
Black titanium stainless steel frame, top panel LED lighting

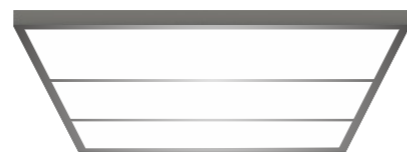

CON-E12

钻石银漆钢配亚克力板
Diamond silver lacquer steel with acrylic plate

Floor Series

地板系列

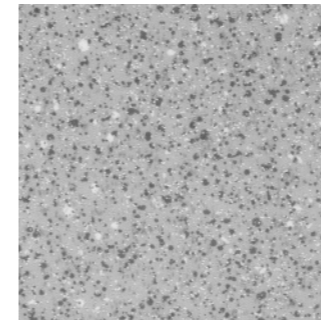

CON-F01

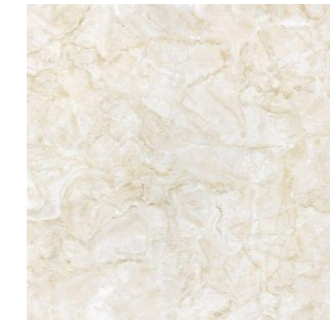

CON-F02



CON-F03

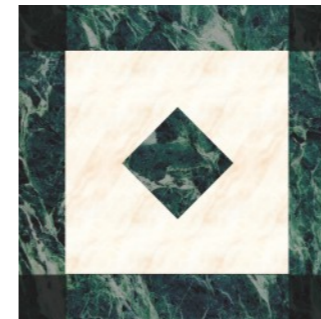

CON-F04

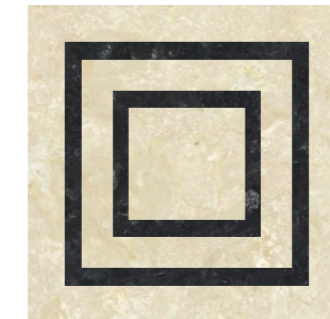

CON-F05



CON-F06



CON-F07



CON-F08



CON-F09



CON-F10



CON-F11



CON-F12

Handrail Series

扶手系列



CON-FS01

镜面不锈钢单管
Mirror stainless steel single tube



CON-FS03

镜面不锈钢扁扶手
Mirror stainless steel flat handrail



CON-FS05

绿松石色亚克力扁扶手
Turquoise acrylic flat handrail



CON-FS02

镜面不锈钢双管
Mirror stainless steel double tube



CON-FS04

钛金不锈钢扁扶手
Titanium stainless steel flat handrail



CON-FS06

钛金不锈钢，青绿色亚克力组合单管
Titanium stainless steel, turquoise acrylic combination single tube

DISPLAY DOOR HORIZONTAL

厅外横显



4.3英寸蓝白LCD显示屏
4.3-inch blue and white LCD display



6.4英寸蓝白LCD显示屏
6.4-inch blue and white LCD display



6.4英寸蓝白LCD显示屏
6.4-inch blue and white LCD display



6.4英寸黑白LCD显示屏
6.4-inch black and white LCD display

ARRIVAL LIGHT

到站灯



Hall Door Series

厅门系列

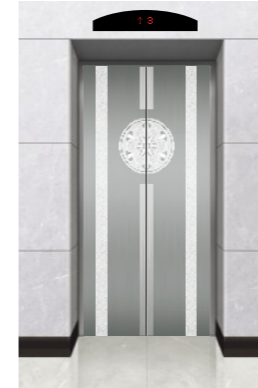

CON-D01

发纹不锈钢，蚀刻
Hairline stainless steel, etched



CON-D02

发纹不锈钢，蚀刻
Hairline stainless steel, etched



CON-D03

发纹不锈钢，蚀刻
Hairline stainless steel, etched



CON-D04

发纹不锈钢，蚀刻
Hairline stainless steel, etched



CON-D05

发纹不锈钢，蚀刻
Hairline stainless steel, etched



CON-D06

发纹不锈钢，蚀刻
Hairline stainless steel, etched

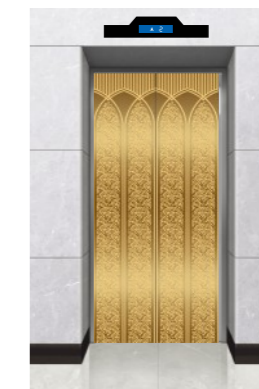

CON-D07

钛金不锈钢，蚀刻
Titanium stainless steel, etched



CON-D08

钛金不锈钢，蚀刻
Titanium stainless steel, etched



CON-D09

钛金不锈钢，蚀刻
Titanium stainless steel, etched



CON-D10

玫瑰金不锈钢，蚀刻
Rose gold stainless steel, etched



CON-D11

玫瑰金不锈钢，蚀刻
Rose gold stainless steel, etched



CON-D12

镜面不锈钢，玻璃门
Mirror stainless steel, glass door

ELEVATOR CABIN & FRAME

电梯轿厢和架子

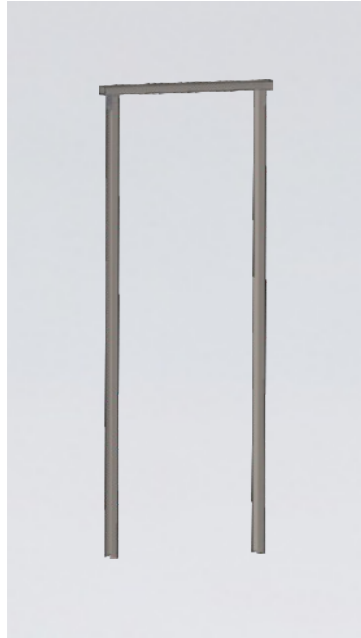

NARROW JAMB
小门套

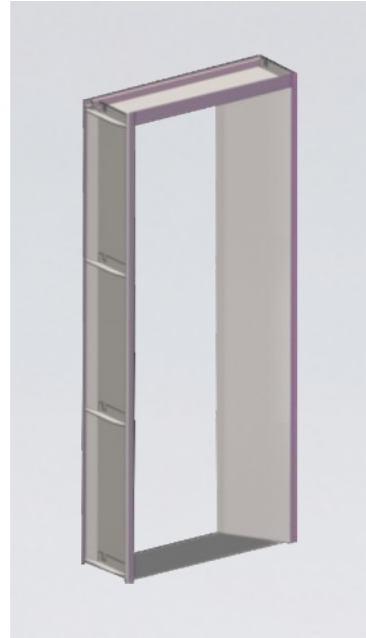

WIDE JAMB TOPLESS
无顶大门套

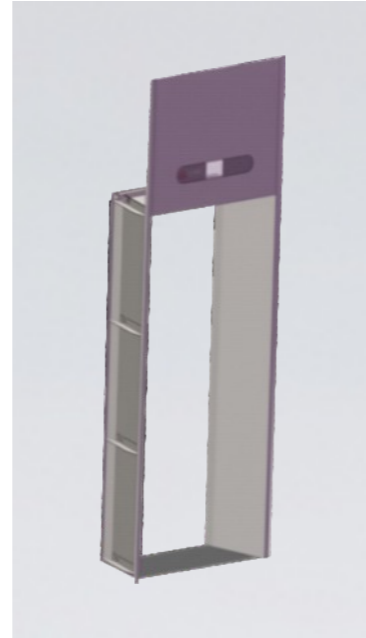

WIDE JAMB FULL HEIGHT
一体式大门套



CONIC SPECIAL WIDE JAMB -1

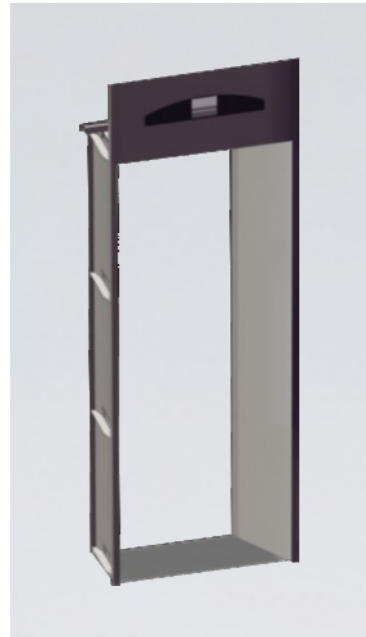

CONIC SPECIAL WIDE JAMB -2

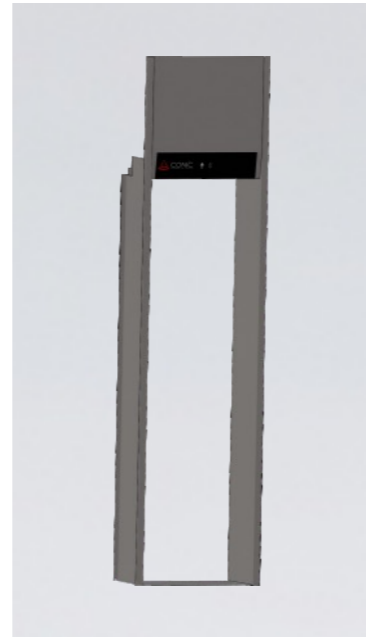

CONIC SPECIAL WIDE JAMB -3



Small machine room passenger Elevator construction parameters

小机房乘客电梯土建参数

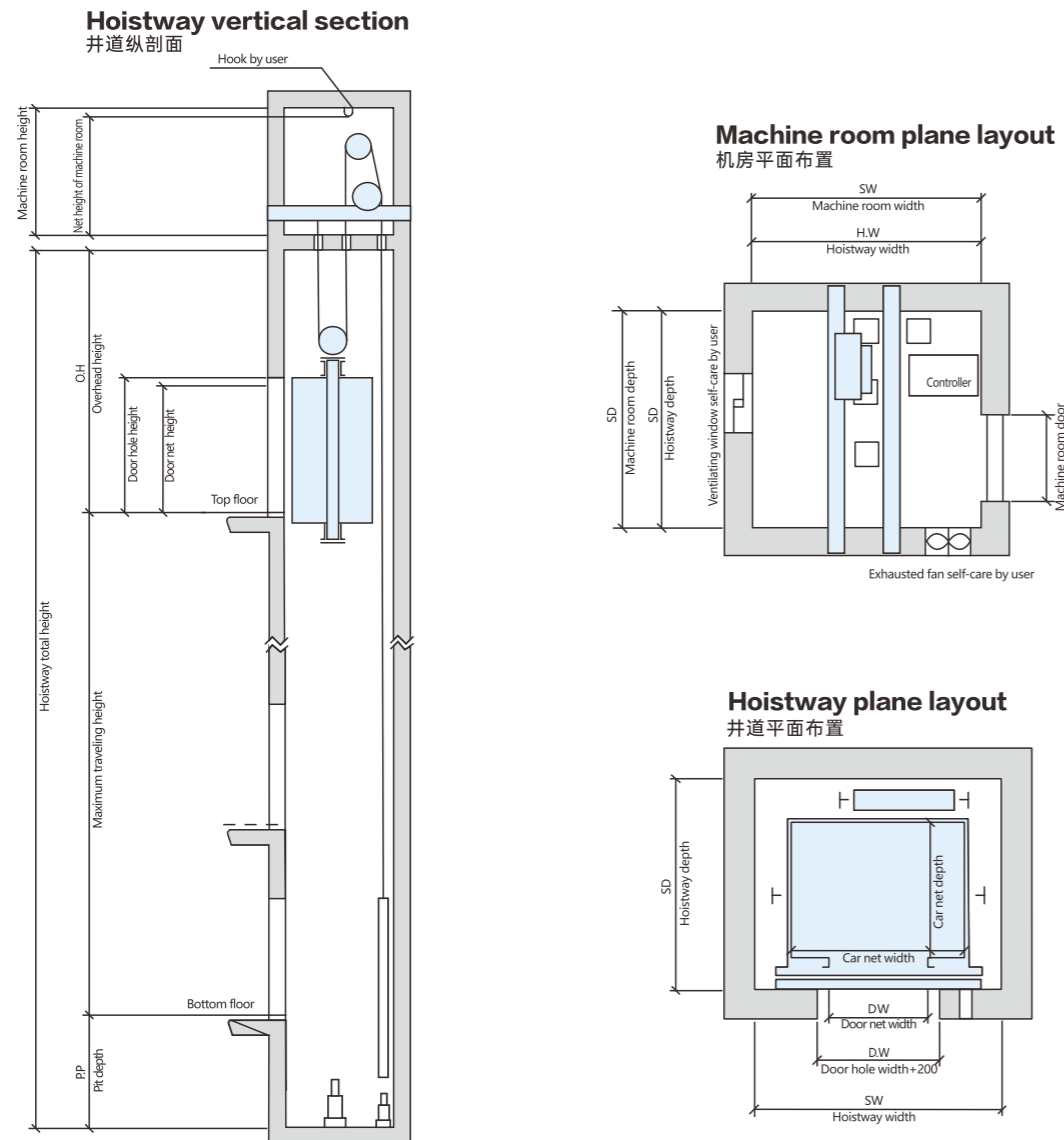

Load (kg) 载重	Speed (m/s) 速度	Car dimension (mm) 轿厢尺寸		Door-opening size (mm) 开门尺寸		Hoistway size (mm) 井道尺寸	Machine room size (mm) 机房尺寸	Overhead height (mm) 顶层高度	Pit depth (mm) 底坑深度	Maximum lifting height (m) 最大提升高度
		Inner size AxB 内部尺寸 AxB	DW Door net opening DW 净开门尺寸	DH Net door height DH 净开门高度	SWxSD					
630	1.0	1400x1100	800	2100	2000x1800	2000x3500	4500	1500	105	
	1.5						4700	1700		
	2.0						4900	2000		
800	1.0	1400x1350	800	2100	2000x2000	2000x3800	4500	1500	105	
	1.5						4700	1700		
	2.0						4900	2000		
1000	1.0	1600x1400	900	2100	2200x2100	2200x2400	4500	1500	105	
	1.5						4700	1700		
	2.0						4900	2000		
1250	1.0	1800x1550	1100	2100	2400x2300	2400x4100	4500	1500	105	
	1.5						4700	1700		
	2.0						4900	2000		
1600	1.0	1950x1700	1100	2100	2600x2450	2600x4500	4500	1500	105	
	1.5						4700	1700		
	2.0						4900	2000		

The data is for design reference only. For the detailed parameters, please take the technical drawing as the criterion.
此数据仅供设计参考，详细参数请以技术图纸为准。

Note: If the specification exceeds above range, please contact us, Ningbo CONIC Elevator Company.

注：若所需规格超出上述范围，请联系宁波肯尼科电梯有限公司。

Machine roomless passenger Elevator construction parameters

无机房乘客电梯土建参数

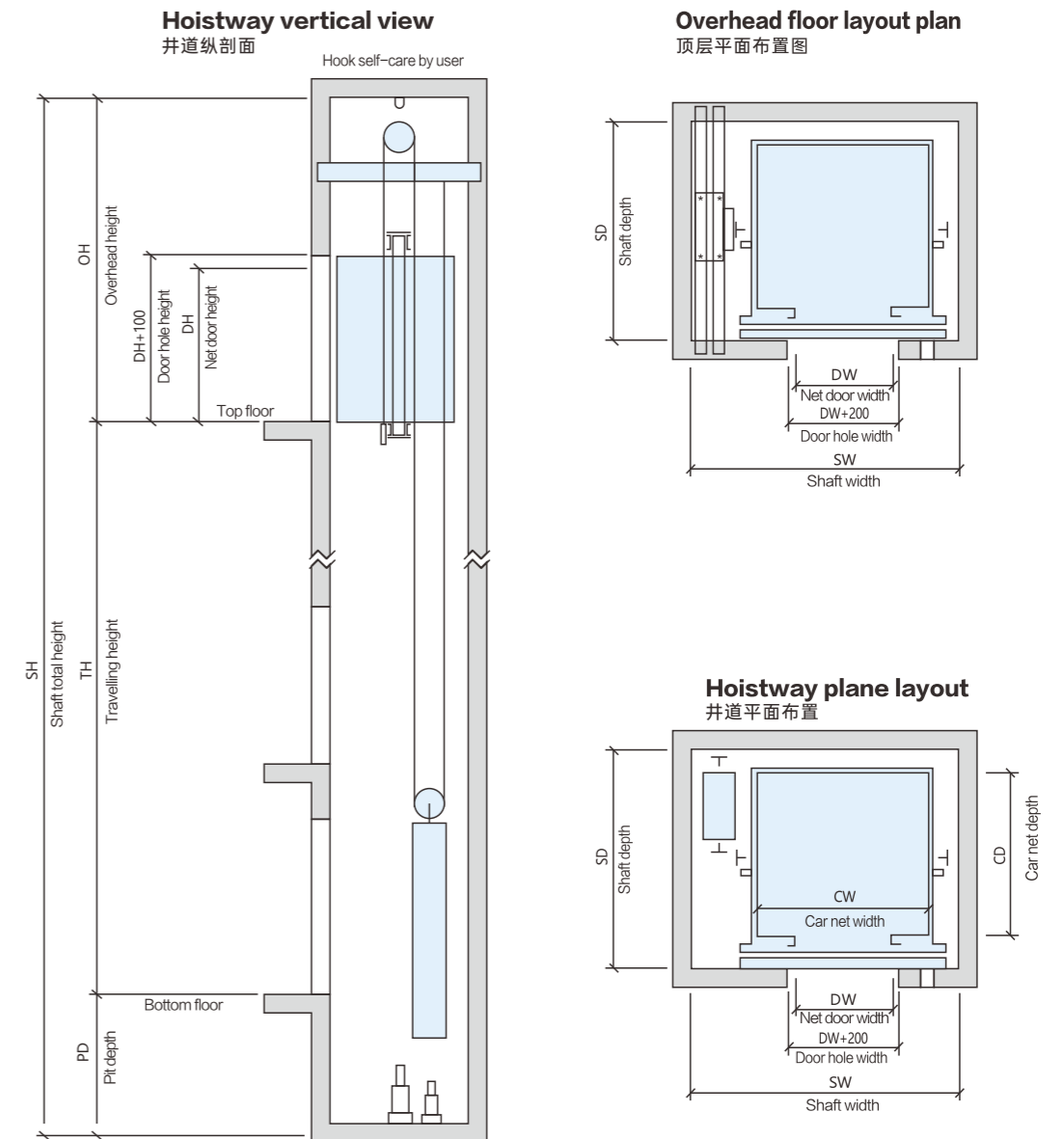

Load (kg) 载重	Speed (m/s) 速度	Car size (mm) 轿厢尺寸		Car door width x height (mm) 轿门宽度x高度	Hoistway size (mm) 井道尺寸	Overhead height (mm) 顶层高度	Pit depth (mm) 底坑深度			
		CWxCD inner size (mm) CWxCD 内部尺寸	CWxCD internal size (mm) CWxCD 内部尺寸							
630	1.0	1200x1300	800x2100	800x2100	2150x1800	4500	1500			
	1.5							2150x1800	4700	1500
	2.0							2250x1900	5000	1700
800	1.0	1400x1350	800x2100	800x2100	2250x2100	4500	1500			
	1.5							2250x2100	4700	1500
	2.0							2350x2200	5000	1700
1000	1.0	1600x1500	900x2100	900x2100	2400x2100	4500	1500			
	1.5							2400x2100	4700	1600
	2.0							2500x2200	5000	1700
1150	1.0	1700x1500	1000x2100	1000x2100	2550x2100	4500	1500			
	1.5							2550x2100	4700	1600
	2.0							2650x2200	5000	1700
1350	1.0	1800x1650	1100x2100	1100x2100	3000x2250	4700	1500			
	1.5							3000x2250	4900	1600
	2.0							3100x2350	5100	1800
1600	1.0	2000x1700	1200x2100	1200x2100	3200x2300	4700	1500			
	1.5							3200x2300	4900	1600
	2.0							3300x2400	5100	1800

The data is for design reference only. For the detailed parameters, please take the technical drawing as the criterion.
此数据仅供设计参考，详细参数请以技术图纸为准。

Note: If the specification exceeds above range, please contact us, Ningbo CONIC Elevator Company.
注：若所需规格超出上述范围，请联系宁波肯尼科电梯有限公司。

Elevator Function Table

电梯功能表

标准功能 Standard function

功能名称 Function	功能说明 Description of functions
自动运行 Automatic operation	电梯根据给定指令自动运行、停车、开关门。 The lift automatically runs and stops, opens / shuts the door according to designated command.
司机运行 Operation by operator	电梯根据给定指令自动运行、停车，手动关门。 The lift automatically runs and stops, manually shuts the door according to designated command.
检修运行 Overhaul operation	检修状态时，通过操作慢上慢下按钮，使电梯检修速度运行。 Under repair and inspection conditions, the lift runs at inspection speed through operating "slow up / slow down" buttons.
上电自动开门 Upper automatic door-opening	电梯上电，轿厢正在门区，则自动开门。 When the lift is electrified and the car is in the door zone, it will open the door automatically.
自动关门延时 Automatic door-shut time-delay	轿门完全打开后，保持开门状态，经过延时后自动关门。 After the car door has been opened completely, it keeps the door open condition. It automatically shuts the door after time-delay.
本层外召开门 Call for opening of this floor	电梯正在关门或已关门但未启动，若本层外召，则重新开门。 When the lift is shutting the door or it does not start but has closed the door, when there is any outer calling from this landing, it will reopen the door.
安全触板、光幕保护 Safety touch board, optical curtain protection	触动安全触板或光幕被遮挡时，关门动作立即停止自动开门。 When safety touch board has been touched or optical curtain has been shaded, it immediately stops door-shut action and automatically opens the door.
超载不关门 Over-load none door-shut	超载时不关门，超载灯亮，蜂鸣器鸣响，轿厢内显示CZ或超载，电梯不启动。 It does not shut the door in overload. And it is bright from overload lamp. The buzzer rings. It shows CZ or overload in the car and does not start the lift.
满载直行 Full-load direct running	达到额定载荷时，只响应内选，不响应外召。 When it reaches the rated load, it only responds to internal selection instead of outer calling.
自动照明控制 Automatic lighting control	规定时间内，电梯没有接收到运行指令，照明自动熄灭，有指令时自动打开。 In the stipulated time, if the lift does not receive any travel command, the lighting will automatically die out. It automatically opens at command.
消防返回 Firefight return	基站消防开关启动，所有指令均被取消，电梯立即驶往指定救援层站停靠。 When it starts home landing fire-fighting switch, all the commands will be cancelled then. The lift immediately drives to the designated landing and park there.
误操作消除 Mal-operation removal	重复操作内选按钮，即可撤销误选登记。 Repeatedly operate internal selective button to cancel mal-operation registration.
重复关门 Main contactor protection	执行关门指令后，在规定时间内门没有关闭到位，重新开门后再关门。 After the lift executes door-shut command, if the door has not been closed within the stipulated time, it will re-open the door and then shut it again.
服务楼层设置 Service floor setting	电梯仅对所设楼层进行服务。 The lift only serves the set floor.
基站楼层设定 Home landing floor setting	在自动状态，在一定时间内无指令时，轿厢自动运行到设定层站。 Under the automatic condition, if there is no command within certain period, the car will automatically run to the set landing.
轿内层楼、方向显示 Landing floor, direction display in the car	轿内显示电梯所在层楼及将要运行的方向。 It shows the landing floor of the lift, the direction where the lift is going to travel in the car.
司机选择定向 Direction chosen by driver	根据司机给定指令确定运行方向。 The running direction is determined by the driver's directive.
贯通门服务设置 Opposite door service setting	按照服务设置在相应楼层正确开、关门。 Correctly open / shut the door in the corresponding floor according to service setting.
故障自诊断 Trouble diagnosis	当运行时发生故障，自动诊断故障原因，并在控制板上显示，将最近故障信息自动保存。 When there is something wrong in the travel process, it will automatically diagnose the trouble cause, display in the operation panel and automatically store the latest trouble information.
安全回路保护 Safety circuit protection	安全回路断开，电梯将立刻停止运行。 If safety circuit is disconnected, the lift will immediately stop the travel.
门联锁保护 Door interlocking protection	全部门联锁都闭合，电梯方能运行。如果运行中门联锁断开或抖动，电梯将停止运行。 If it closes all of door interlocking, it can then start the lift. If door interlocking is disconnected or trembled, the lift will stop the operation.
运行接触器保护 Travel contactor protection	系统可检测电机回路接触器动作是否可靠，如果发现异常，将停止电梯运行。 The system can detect whether motor circuit contactor action is reliable or not. If any abnormal condition happens, it will stop the lift travel.

标准功能 Standard function

功能名称 Function	功能说明 Description of functions
抱闸检测保护 Brake test protection	通过抱闸臂检测开关对抱闸的打开与闭合实时监测。当抱闸未按要求打开时，系统将禁止电梯启动。 It implement real-time monitor to the brake open / shut through brake arm test switch. If the brake has been opened improperly, the system will not allow the lift to start.
端站换速及楼层号校正 Terminal speed change and landing floor number correction	系统在运行中检测到端站开关后，电梯将强迫换速并自动校正楼层显示。 After the system detect terminal switch in travel, the lift will be forced to change the speed and automatically correct the landing floor display.
限位保护 Position-Limit protection	系统检测到限位开关动作，将立刻停止电梯运行。 If the system detects limit switch action, it will immediately stop the lift travel.
极限保护 Limit protection	系统检测到极限开关动作，整个系统将立刻掉电。 If the system detects limit switch action, the whole system will immediately lose power.
超速保护 Over-speed protection	当电梯上下行超过额定速度1.2倍时，切断控制电源，电梯将停止运行。 When the lift up / down exceeds 1.2 times of the rated speed, it will cut off control mains and stop the lift travel.
防轿厢意外移动系统 Lift car anti-moving system	精确灵敏的轿厢意外移动检测装置，不间断检测轿厢每一个细微变化，有效确保乘客安全。 The precise and sensitive lift car moving test device can test every minor change of the lift car, efficient protection for passengers.

选配功能 optional function

功能名称 Function	功能说明 Description of functions
消防运行 Fire-fighting running	消防开关闭合后，系统进入消防运行。 After fire switch is closed, the system enters into fire-fighting running.
并联控制 Parallel connection control	两台电梯并联控制，按照快速节能原则自动响应，提高电梯运行效率。 Two-lift parallel connection control automatically responds the command according to rapid energy-saving principle so as to increase the lift travel efficiency.
群控运行 Group supervision travel	系统可同时控制8台电梯运行，功能如并联控制。 The system can simultaneously control the travel of eight-lift. The function is the same as that of parallel connection control.
防捣乱 Anti-nuisance	电梯运行至最远端楼层清除所有的内选登记，若有负载检测装置，轻载内选最多登记3个。 When the lift travels to the furthest floor, it will remove all the internal selective register. If it has load tester, it will have three light-load internal selections at most.
应急自动平层运行 Emergency automatic leveling operation	电网停电后电梯应急自动平层控制装置供电运行平层，让乘客安全离开。 After the electric net power failure, the lift emergency automatic leveling control device supplies power to travel leveling so that the passengers can leave there safely.
层站层楼、方向显示 Landing floor, direction display	层站显示电梯所在层楼及将要运行的方向。 The floor landing shows the landing floor that the lift travels and where it travels also.
语音报站 Voice arrival	在正常运行到站的情况下，利用语音装置告知乘客有关信息。 Under the condition of normal travel arrival, voice announcer is used to announce the related passengers' information.
轿厢到站钟 Car arrival gong	装于轿厢的电子钟的钟声告知乘梯的乘客电梯已到站。 The electric gong that is installed in the car announces the passenger lift arrival to vast passengers.
厅外到站钟 Hoist-way hall arrival gong	装于待梯区的电子钟的钟声告知候梯的乘客电梯已到站。 The electronic gong in the waiting zone announces the lift arrival to the waiting passengers.
智能召唤服务 Intellectual calling service	只要通过专用的智能输入设备，可使轿厢指令或厅外召唤锁定或接通。 The car command or hoist-way hall calling can be locked or connected through the special intellectual input equipment.
残疾人服务 Service to the handicapped	专门为残疾人服务的人机界面。 Man-machine interface specially serves the handicapped people.
电子刷卡系统 Electronic Punch Card System	乘梯时需先刷卡后使用，使无卡或无权限人员无法使用电梯，加大了物业的安全管理，可有效节省大楼电力损耗。 The users shall swipe card in using the elevators. Those who do not have cards or have no jurisdiction can't use the elevators. It enlarges the safety management of the house property personnel and effectively saves power loss in the buildings.
能量回馈装置 Energy feedback device	使电梯的再生电力提供给大楼内，并有效地适用于大楼内的照明等，减少消耗的电量。 It offers regenerated lift power to the buildings. It is effectively applicable for lighting in the buildings etc. so as to reduce the consumed power.

VitaPass[®] Series

Hospital Elevator Series

医用电梯系列

充分考虑医疗机构的特殊需求，优化车辆结构，方便病床、医护人员等医疗设备的运输；仔细考虑操纵箱、扶手等每一个细节，营造健康安全的出行空间。

Fully consider the special needs of medical institutions, optimize the car structure to facilitate the transportation of hospital beds, medical staff and other medical equipment; carefully consider every detail such as the control box and handrails to create a healthy and safe travel space.

轿厢空气消毒净化解决方案

Car air sterilization and purification solution

电梯专用负离子发生器和紫外线消毒灯等五层过滤器，可实现车内空气的快速循环和净化，有效消除空气中的灰尘和细菌。

The special negative ion generator and ultraviolet sterilization lamp and other five layer filter for the elevator can achieve the fast circulation and purification of the air in the car and effectively eliminate the dust and bacterium in the air.

深度大、超重、优化的车厢结构，可以轻松容纳担架和床位，满足医院的特殊需求。绿色、环保、安全节能，给予用户细致的关怀。

Large depth, super heavy load, optimized car structure, can easily accommodate stretchers and beds to meet the special needs of hospitals. Green, environmentally friendly, safe and energy-saving, giving users meticulous care.

量身定制，安全可靠

Tailor-made, safe and reliable

高负荷运营能力满足高频、承载力强符合电梯的场所要求，并配备大深度车，满足医院床位日常运输的要求。

The high-load operation capacity meets the requirements of high-frequency, strong-carrying places with elevators, and is equipped with a large depth car to meet the requirements of daily transportation of hospital beds.

多种开门方式

Multiple door opening methods

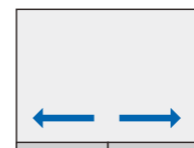

中分门
Center opening type



旁开门
Side opening type



CON-VP-1

标配/Standard

- 吊顶：发纹不锈钢、亚克力灯、LED灯
- 轿壁：发纹不锈钢
- 轿门：发纹不锈钢
- 扶手：不锈钢平板扶手
- 地板：PVC

- Ceiling：Hairline stainless steel, acrylic, LED light
- Car wall：Hairline stainless steel
- Car door：Hairline stainless steel
- Handrail：Stainless steel flat armrest
- Floor：PVC



TitanHaul[®] Series

Freight Elevator Series

载货电梯系列

重载千钧，胜任有余

It bears any Heavy load ease, more than competent

载货电梯均采用先进的微电脑模块化电梯专用控制系统，融合高效的驱动方式、灵敏的VVVF变频门机，使其在各种工况下轻松运载、应变自如。

Cargo elevators all adopt advanced microcomputer modular elevator special control system, fusion of efficient drive mode, and sensitive VVVF variable frequency door machine, making it easy to carry and respond freely under various working conditions.

高强度，稳固耐用

High strength, stable and durable

高强度型材轿架与特殊加强的轿厢底盘完美结合，确保轿厢坚实耐用。

The combination of high strength section car frame and special reinforced car chassis ensures that the car is strong and durable.

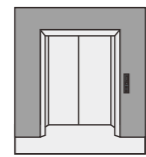

旁开双折门
Side opening door

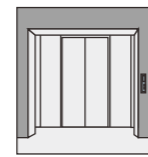

中分双折门
Two speed and center opening door

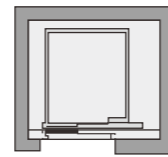

单通门
Single door

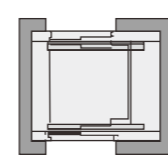

贯通门
Through the door

地板

Floor



GN-FL01

标配/Standard

普通花纹钢板
Ordinary pattern steel plate



GN-FL02

选配/Optional

不锈钢花纹钢板
Stainless steel plate with patterns

CON-TH-1

标配/Standard

吊顶：喷涂钢板
轿壁/门：喷涂钢板
照明：嵌入式节能荧光灯
开门方式：侧开门式
地板：超薄钢板

Ceiling: Sprayed steel plate
Cabin wall / door: Sprayed steel plate
Illuminate: Embedded energy-saving fluorescent lamp
Door opening mode: Side opening type
Floor: Checked steel plate



地板

Floor



GN-FL01

标配/Standard

普通花纹钢板
Ordinary pattern steel plate

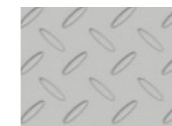

GN-FL02

选配/Optional

不锈钢花纹钢板
Stainless steel plate with patterns

CON-TH-2

选配/Optional

吊顶：发纹不锈钢
轿壁/门：发纹不锈钢
照明：荧光灯
开门方式：中开门双折叠式
地板：超薄钢板

Ceiling: Hairline stainless steel
Cabin wall / door: Hairline stainless steel
illumination: Fluorescent lamp
Door opening mode: Center-opening & double folded type
Floor: Checked steel plate



Compact triple stacker Parking Lift

紧凑型三层停车设备

以3层停车电梯的形式，以最低的建设和维护成本创建额外停车位的生态解决方案。提供具有成本效益的解决方案以满足室内和室外的不同需求。

缩短的柱子高度使其在低矮的天花板空间中非常灵活。每个电梯最多可容纳2辆SUV和1辆轿车，每辆电梯的空间。两款车型的上平台承载能力均为2000公斤，下平台可容纳最高2500公斤的车辆。

Eco-solution for creating additional parking spaces with minimal construction and maintenance costs in the form of a 3-level parking lift. Providing cost-effective solutions to meet different demands for indoor and outdoor purposes.

Shortened posts' height makes it highly exible in low ceiling spaces. Each lift accommodates max 2 SUVs and 1 sedan on the space of one. The upper platform has capacity of 2000kg, and the lower platform can receive vehicles up to 2500kg.



规格说明 Specification

- 商用级设计
- 结构紧凑，配有 4 根立柱
- 专利设计的重叠平台
- 平台承载能力：2500 千克（MF 型）和 2000 千克（UF 型）
- 宽广的自动点餐通道，可达 2492 毫米
- 车辆高度：最高可达 2050 毫米
- 缩短的立柱高度使空间利用更加灵活
- 3.0 千瓦强劲液压力装置
- 每根立柱配备多处防坠落锁扣
- 锁扣失效检测功能
- 上下操作键开关
- 每个平台配备防尘/防油滴落托盘
- 采用阿克苏诺贝尔耐磨粉末涂层处理，经久耐用

- Commercial-grade design
- Compact structure with 4 posts
- Patented design of overlapped platforms
- Platform load capacity: 2500kg (MF) & 2000kg (UF)
- Wide drive-thru up to 2492mm
- Car height: up to 2050mm
- Shortened post height allows tting in more spaces
- 3.0kw strong hydraulic power pack
- Multiple anti-fall locks along each post
- Lock-release failure detection
- Up & down key switch
- Dust/oil dripping tray on each platform
- Durable powder coating nishing supported by Akzo Nobel

尺寸 Dimensions

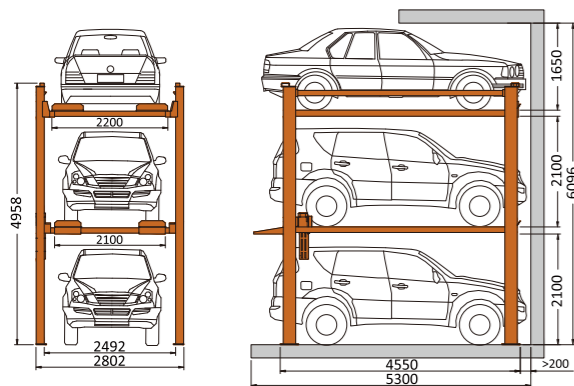

Hydro-Park 2525

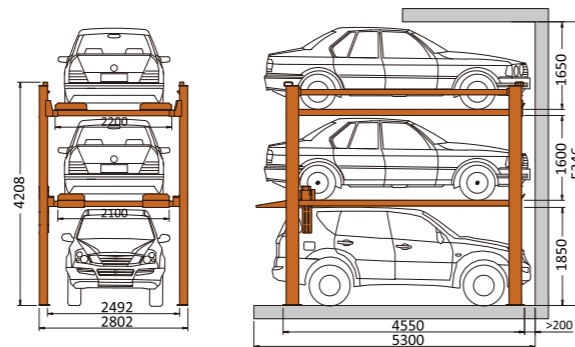

Hydro-Park 2625

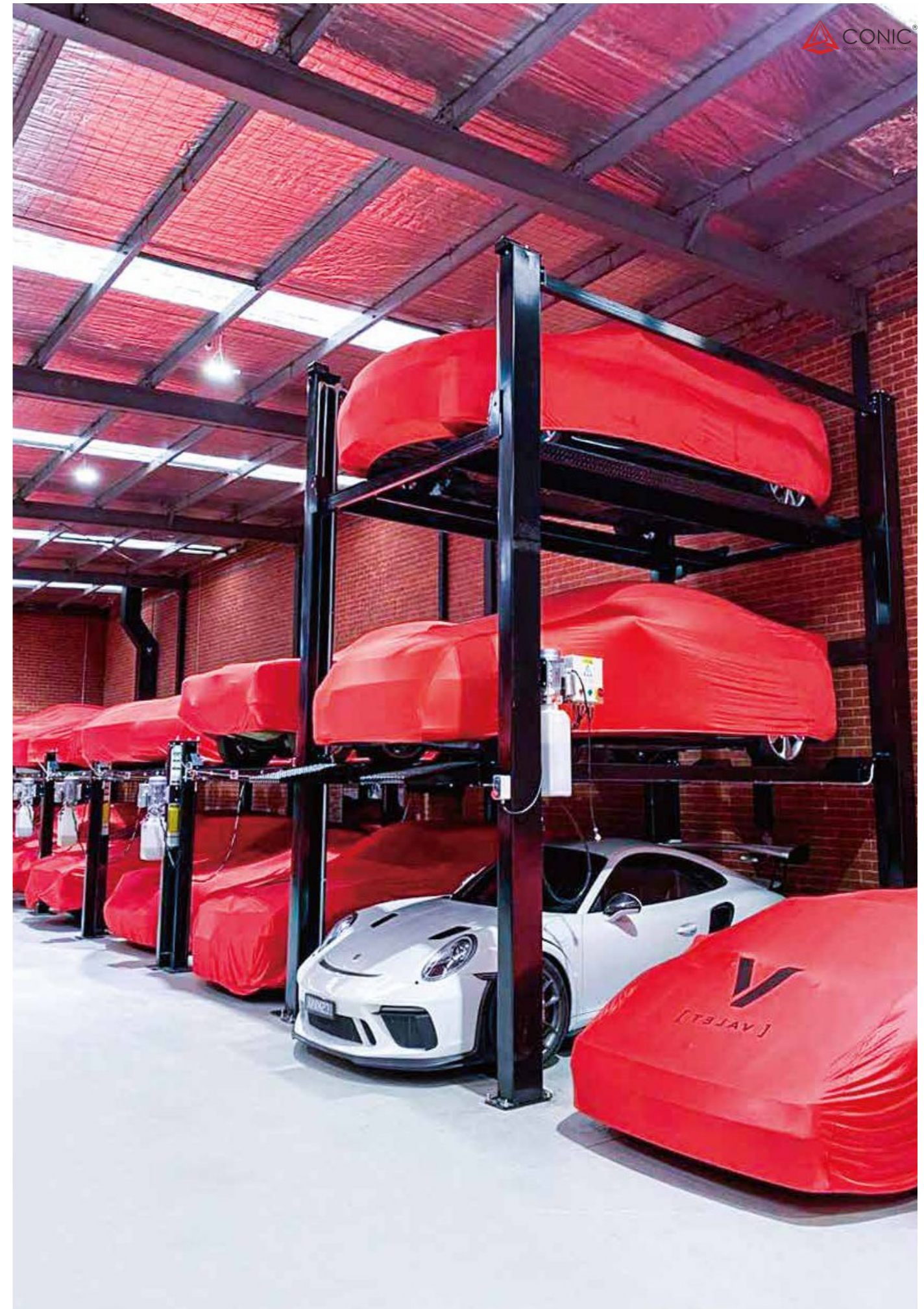

SilkVey[®] Series

Dumbwaiter Elevator

循环链条式传菜机

- 1. 高效益**
传菜机中速运转时每小时有720个传菜盘通过,炒盘可传送1440个。
- 2. 安全好用**
传菜机不属于特种设备,无需报批、验收、年审等手续。本传菜机没有任何安全隐患,人性化操作,传菜员可得到充分的保障。
- 3. 高智能设**
备智能控制中心由单片机、光电传感器等组成,光电一体化,预设多种控制系统。
- 4. 易维护**
所有机械、传动设备负荷均按实际负荷几倍的设计,电子元件均采用军工级产品,具有极高的可靠性。
- 5. 环保节能**
框架采用热镀锌钢材,取菜口采用304不锈钢,环保美观耐腐蚀,本产品实际消耗功率仅200多瓦,满负荷工作5小时,仅消耗一度多电。
- 6. 配套简单**
无需底坑,楼层高度无限制,顶层设备高度仅1.8米,楼板承受力无特殊要求,且开孔尺寸小,最小宽度仅800mm,可保证在商场、写字楼等飞专用场所开酒楼的需要。

- 用户需完成的工作
1. 提供设备安装空间,框架结构需要在设备安装楼板位置预留或开孔。
 2. 井道高度不大于24米,垂直误差不大于30mm。
 3. 提供220v或380v电源至控制柜处,并设立独立电源开关,且零线和地线始终分开。
 4. 循环传菜机安装完毕后,外装修由用户负责。

- 1. High efficiency**
When the dish conveyor operates at medium speed, 720 serving trays pass through per hour, and 1440 frying trays can be transported.
 - 2. Safe and user-friendly**
The dish conveyor is not a special equipment and does not require approval, inspection, annual review, etc. This dish conveyor has no safety hazards. The operation is user-friendly, and the dish servers can be fully protected.
 - 3. Highly intelligent equipment**
The intelligent control center of the dish conveyor is composed of a single-chip microcomputer, photoelectric sensors, etc. It is photoelectric integrated and has multiple preset control systems.
 - 4. Easy maintenance**
All mechanical and transmission equipment are designed with loads several times the actual load. The electronic components all use military-grade products, which have extremely high reliability.
 - 5. Environmentally friendly and energy-saving**
The frame is made of hot-dip galvanized steel, and the take-out opening is made of 304 stainless steel. It is environmentally friendly, beautiful, and corrosion-resistant. The actual power consumption of this product is only over 200 watts. When operating at full load for 5 hours, it only consumes one and a half degrees of electricity.
 - 6. Simple installation**
No pit is required. There are no restrictions on floor height. The height of the equipment on the top floor is only 1.8 meters. The floor plate has no special requirements for bearing capacity, and the opening size is small, with the minimum width being only 800mm. This can ensure the needs of opening restaurants in dedicated places such as shopping malls and office buildings.
- Tasks for the user to complete:
1. Provide space for equipment installation. The framework structure needs to be reserved or have holes drilled at the position of the equipment installation floor.
 2. The shaft height should not exceed 24 meters, and the vertical error should not exceed 30mm.
 3. Provide 220v or 380v power supply to the control cabinet and set up an independent power switch. The neutral wire and ground wire should always be kept separate.
 4. After the circulating dish conveyor is installed, the exterior decoration is the responsibility of the user.

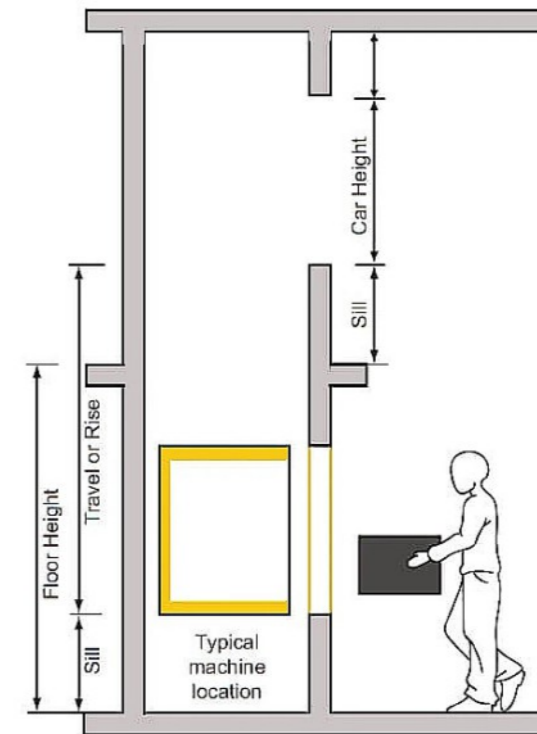
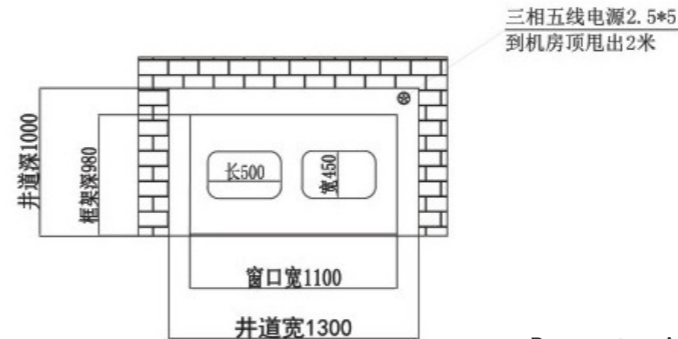
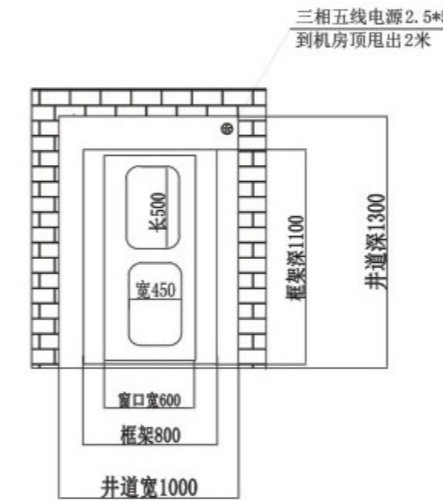

Parameter size of vegetable conveyor
传菜机参数尺寸

规格 Specification	铁框架 Iron frame	铝框架 Aluminum frame
托盘载重(Kg) Pallet Load Capacity (Kg)	8	8
托盘尺寸(mm) Pallet Size (mm)	500x450	600x400
门口尺寸 (A1宽XH高mm) Doorway dimensions (A1 width x H height mm)	450x700	1300x700
框架尺寸(A宽XB深) Frame dimensions (A width x B depth)	800x1200	1600x800
井道尺寸(C宽XD深) Paired lane dimensions (C width x D depth)	1300x1000	1700x1200

